

# DECLARATIONS OF CANDIDACY

ASSESSOR—PUBLIC DEFENDER

PROPOSITIONS, ARGUMENTS

and

STATEMENTS OF CONTROLLER

Relating to Costs

to be voted on at

**GENERAL ELECTION**

to be held

**NOVEMBER 2, 1954**



Attest

**Thos. A. Toomey,**

Registrar of Voters.

Published under provisions of Sections 176 and 183 of the Charter of the City and County of San Francisco

## INDEX

	Page
George M. Del Secco.....	2
Edward T. Mancuso.....	4
William C. McDonnell.....	5
Russell L. Wolden.....	3

## Propositions

A. Exhibit Hall Bonds, 1954.....	6
B. Recreation Center Bonds, 1954.....	10
C. San Francisco Hospital Bonds, 1954.....	14
D. Laguna Honda Home and Hospital Bonds, 1954.....	18
E. Civil Service Examinations for qualified blind persons.....	22
F. Salaries, bonds and meetings; Board of Supervisors.....	23
G. Chief Administrative Officer; appointment and removal.....	26
H. Retirement and disability benefits; ambulance drivers and stewards.....	27
I. Retirement and disability benefits; Sheriff's Deputies.....	32
J. Cable Car Initiative Petition.....	36

**For Assessor**  
**GEORGE M. DEL SECCO**

I hereby declare myself a candidate for the office of Assessor for the City and County of San Francisco, State of California, to be voted for at the General Election to be held in the said City and County on November 2, 1954, and declare the following to be true:

That I shall have been a resident of the City and County of San Francisco for a period of at least five years and an elector thereof for a period of at least one year immediately prior to the time for taking such office: That my name is George M. Del Secco. My residence address is at No. 314 Fair Oaks St., San Francisco. My business or occupation is Businessman (Real Estate).

My qualifications for said office are as follows:

Twenty-eight years with the interest of San Francisco at heart. Father of two daughters. Attended St. Anthony's and Mission Dolores primary schools. Attended Balboa High School prior to enlistment in the United States Navy, W.W. 2. After completing three years in the Pacific, continued his education at Golden Gate College. Has maintained, owned and established his own business eight years. Is actively engaged in the following organizations: American Legion (Housing Committee), South of Army Mission Merchants (Board of Directors), National Association of Real Estate Boards, Civic Mortgage Corporation (Treasurer), Fairmount Improvement Association—Aim, Better Government, by Better Representation.

Pursuant to the provisions of Section 175 of Charter of said City and County, I desire that the following designation "Businessman" be placed immediately under my name as it will appear on all ballots at the General Election to be held November 2, 1954.

Signature of Candidate: GEORGE M. DEL SECCO.

Subscribed before me and filed this 28th day of September, 1954.

THOS A. TOOMEY,  
Registrar of Voters.  
By CHAS. A. ROGERS,  
Deputy Registrar of Voters.

The sponsors for George M. Del Secco are:

Mrs. Gloria Barnett, 2690 Alemany Blvd.; Housewife.  
G. H. Benckert, 3406 Mission St.; Retired (Storekeeper).  
A. R. Benjamin, Sr., 1225 Alemany Blvd.; Janitor.  
R. L. Camisa, 230 Justin Drive; Real Estate Broker.  
Edward James Glinden, 2251 Moraga Street; Real Estate and Insurance Broker.  
Harold V. Greer, 845 Monterey Blvd.; Drapery Wholesale and Resale Business.  
John F. Harper, 645 Lake St.; Attorney.  
Frank P. Knight, 25 Cervantes Blvd.; Real Estate Broker.  
Ramona Lukaszevig, 3124-25th Street; Clerk.  
Mrs. Gloria M. Pease, 1301 Guerrero; Clerk Typist.  
Emilio Ruta, 2824-23rd Street; Real Estate Broker and Notary.  
Marie J. Skinner, 281 Cayuga Ave.; Housewife.  
Paul Rene Tula, 841 Dolores; Real Estate Salesman.

**For Assessor**

**RUSSELL L. WOLDEN**

I hereby declare myself a candidate for the office of Assessor for the City and County of San Francisco, State of California, to be voted for at the General Election to be held in the said City and County on November 2, 1954, and declare the following to be true:

That I shall have been a resident of the City and County of San Francisco for a period of at least five years and an elector thereof for a period of at least one year immediately prior to the time for taking such office: That my name is Russell L. Wolden. My residence address is at No. 2100 Pacific Ave., San Francisco. My business or occupation is Assessor of the City and County of San Francisco.

My qualifications for said office are as follows:

Under my direction, the office of Assessor has been conducted efficiently, economically, and impartially. The modern assessment procedures of my office have received national recognition and commendation. Courteous service has been the watchword of the office, with every effort made to render complete service and assistance to the public. I have administered the affairs of the office in a strictly non-political manner, assessing all taxable property in the County without regard for the political fortunes of any individual or group.

Pursuant to the provisions of Section 175 of Charter of said City and County, I desire that the following designation "Incumbent" be placed immediately under my name as it will appear on all ballots at the General Election to be held November 2, 1954.

Signature of Candidate: RUSSELL L. WOLDEN.

Subscribed before me and filed this 21st day of September, 1954.

THOS. A. TOOMEY,  
Registrar of Voters.

The sponsors for Russell L. Wolden are:

Mrs. Virginia Wolden, 2100 Pacific; Housewife.  
C. J. Goodell, 2825 Lincoln Way; Attorney-at-Law.  
J. Rufus Klawans, 27 Avila Street; Attorney.  
Wm. Esser, 3650 Fillmore St.; Retired.  
Mary I. Murphy, 1418-25th Ave.; Housewife.  
Chauncey Tramutolo, 2140 Pacific Ave.; Attorney-at-Law.  
Daniel F. Del Carlo, 3445 Pierce St.; Labor Representative.  
Bert F. Rabinowitz, 1275 Greenwich; Attorney.  
Cyril J. Magnin, 505 Geary St.; Merchant.  
Wm. McKinley Thomas, M.D., 2723 Sacramento St.; Doctor of Medicine.  
Frank Cames, 285 Bartlett St.; Retired.  
Geo. H. Thomas, Jr., 345 San Leandro Way; Real Estate Broker.  
George H. Sandy, 2201 Pacific Ave.; Real Estate Investments.  
Paul Verdier, 1731 Polk St.; Laundry Owner, Ex-Pres. Lafayette Club.  
W. G. Gilmore, 2950 Vallejo St.; Steel Merchant.  
Robert Grison, 2296 Vallejo St.; Restaurant Owner.  
Henry A. Tagliaferri, 282 Silver Ave.; Dentist.  
Edmund J. Morrissey, 2700 Vallejo St.; Physician.  
Harold T. Lopez, 1801 Wawona; Sec. & Bus. Mgr. Teamsters Union, Local 85.  
Thomas R. O'Day, 894-25th Ave.; Retired.

**For Public Defender**  
**EDWARD T. MANCUSO**

I hereby declare myself a candidate for the office of Public Defender for the City and County of San Francisco, State of California, to be voted for at the General Election to be held in the said City and County on November 2, 1954, and declare the following to be true:

That I shall have been a resident of the City and County of San Francisco for a period of at least five years and an elector thereof for a period of at least one year immediately prior to the time for taking such office: That my name is Edward T. Mancuso. My residence address is at No. 520 Crestlake Drive, San Francisco. My business or occupation is Public Defender.

My qualifications for said office are as follows:

Every person accused of crime is entitled to a fair defense. By law it is the duty of the Public Defender to protect the legal rights of those financially unable to employ private counsel. My 25 years' experience as a trial lawyer enables me to conduct the office of Public Defender efficiently and economically. Cases are brought to trial speedily, thereby protecting the rights of the accused and of the taxpayers. If retained in office I shall continue to fulfill my legal, ethical and moral obligations to the people and to those dependent upon me for legal representation.

Pursuant to the provisions of Section 175 of Charter of said City and County, I desire that the following designation "Incumbent" be placed immediately under my name as it will appear on all ballots at the General Election to be held November 2, 1954.

Signature of Candidate: EDWARD T. MANCUSO.

Subscribed before me and filed this 13th day of September, 1954.

THOS. A. TOOMEY,  
Registrar of Voters.  
By P. J. O'SHAUGHNESSY,  
Deputy Registrar of Voters.

The sponsors for Edward T. Mancuso are:

Dorothy E. J. Mancuso, 520 Crestlake Drive; Housewife.  
Frank N. Belgrano, Jr., Clift Hotel, S.F., Cal.; Chairman & Pres. Transamerica Corp.  
Helen Bissinger Bloch, 3712 Jackson St.; Housewife.  
Matthew J. Boxer, 65 Paloma Ave.; Merchant.  
Grace R. Butterfield, 262-20th Ave.; Housewife.  
Mrs. Ann S. Dippel, 160 Valdez Ave.; Civic Activities.  
C. A. Ertola, 775 Francisco; Dental Surgeon.  
Adrien J. Falk, 2100 Pacific Ave.; Executive.  
Herbert Hanley, 145 Westgate Drive; Insurance Broker.  
George Hardy, 1653-16th Ave.; Labor Official, In't V. P. Bldg. Serv. Emp. Int. Un. AFL.  
Dr. Francis J. Herz, 2358-14th Ave.; Dentist.  
Wm. Kilpatrick, 2491-24th Ave.; Labor Official.  
Walter McGovern, 2750 Fulton St.; Lawyer.  
Molly H. Minudri, 1 Merced Ave.; Attorney-at-Law.  
Maurice Moskovitz, 2900 Lake St.; Real Estate.  
Raymond J. O'Connor, 1370 Portola Drive; Attorney-at-Law.  
Lillian W. Podesta, 29 San Leandro Way; Housewife.  
James A. Roche, 2331-35th Ave.; Dispatcher of Ship Clerks Assn.  
Ernest L. West, 165 Marina Blvd.; Security Salesman.  
Dr. Thomas Wai Sun Wu, 1170 Jackson St.; Dentist.

**For Public Defender**  
**WILLIAM C. Mc DONNELL**

I hereby declare myself a candidate for the office of Public Defender for the City and County of San Francisco, State of California, to be voted for at the General Election to be held in the said City and County on November 2, 1954, and declare the following to be true:

That I shall have been a resident of the City and County of San Francisco for a period of at least five years and an elector thereof for a period of at least one year immediately prior to the time for taking such office: That my name is William C. Mc Donnell. My residence address is at No. 1034 Vallejo Street, San Francisco. My business or occupation is Attorney-at-Law.

My qualifications for said office are as follows:

I was born in San Francisco in 1905 and am married. Education: University of Santa Clara; Georgetown University Law School; University of San Francisco. I was appointed Assistant Public Defender in 1935, received two years military leave in 1942, and was promoted to Chief Deputy Public Defender in 1947. I defended thousands of criminal cases, gaining the respect of Judges and lawyers. I resigned from this position May, 1954, becoming a candidate on the basis of ability, experience and seniority. I ask for your vote so I may continue aiding the unfortunate and needy of my native city.

Pursuant to the provisions of Section 175 of Charter of said City and County, I desire that the following designation "Attorney-at-Law" be placed immediately under my name as it will appear on all ballots at the General Election to be held November 2, 1954.

Signature of Candidate: WILLIAM C. Mc DONNELL.

Subscribed before me and filed this 13th day of September, 1954.

THOS A. TOOMEY,  
Registrar of Voters.

The sponsors for William C. Mc Donnell are:

Anna Mc Donnell, 1034 Vallejo St.; Housewife.

Mrs. Rose Bunch, 1019A Vallejo St.; Retired.

F. Campagnoli, 2609 Larkin St.; Attorney.

Constance Lawrence Dean, 1034 Vallejo St.; Housewife.

John M. Demartini, 1809 Taylor St.; Retired.

Louis Felder, 34 Castro St.; Mortician.

V. T. Greely, 2175-29th Ave.; Bank Manager.

Susie Jane Guittard, 3871 Jackson St.; Housewife.

St. George Holden, 2524 Union St.; Realtor.

Bert Holland, 1270 Fulton St.; Hotel Owner.

Sherman Leland, M.D., 3966 Washington St.; Physician and Surgeon.

George K. Manheim, 570-30th Ave.; Stockbroker.

Frank J. McHugh, 551-7th Ave.; Contractor.

Mae E. Nolan, 645 Bush St.; Retired Congresswoman.

Joseph J. Rosenthal, 1640 Plymouth Ave.; Photographer.

A. E. Schwabacher, Jr., 3050 Pacific Ave.; Investment Banker.

James A. Toner, 1401 Noe St.; Attorney-at-Law.

Alfonso J. Zirpoli, 1761 Beach St.; Attorney-at-Law.

## PROPOSITION A

**Exhibit Hall Bonds, 1954. To incur a bonded indebtedness in the sum of \$3,275,000 for the acquisition, construction and completion of an exhibit hall, including the relocation of utilities, all within the City and County of San Francisco.**

### PROPOSITION A

File No. 11946-2

Ordinance No. 8735

(Series of 1939)

**CALLING AND PROVIDING FOR A SPECIAL ELECTION TO BE HELD IN THE CITY AND COUNTY OF SAN FRANCISCO ON TUESDAY, NOVEMBER 2, 1954, FOR THE PURPOSE OF SUBMITTING TO THE VOTERS OF THE CITY AND COUNTY OF SAN FRANCISCO A PROPOSITION TO INCUR A BONDED DEBT OF THE CITY AND COUNTY TO THE AMOUNT OF \$3,275,000 FOR THE ACQUISITION, CONSTRUCTION AND COMPLETION BY THE CITY AND COUNTY OF SAN FRANCISCO OF THE FOLLOWING MUNICIPAL IMPROVEMENT, TO WIT: AN EXHIBIT HALL, CONSISTING OF A MAIN FLOOR AND ROOF UNDER THE SURFACE OF THE SOUTHERLY ONE-HALF OF THE CIVIC CENTER PLAZA, WITH ACCESS UNDER GROVE STREET TO THE CIVIC AUDITORIUM, WITH ALL OTHER WORKS, PROPERTY, OR STRUCTURES NECESSARY OR CONVENIENT FOR AN EXHIBIT HALL, INCLUDING THE RELOCATION OF UTILITIES, ALL WITHIN THE CITY AND COUNTY OF SAN FRANCISCO, AND THAT THE ESTIMATED COST TO THE CITY AND COUNTY OF SAID MUNICIPAL IMPROVEMENT IS AND WILL BE TOO GREAT TO BE PAID OUT OF THE ORDINARY ANNUAL INCOME AND REVENUE OF THE CITY AND COUNTY AND WILL REQUIRE AN EXPENDITURE GREATER THAN THE AMOUNT ALLOWED THEREFOR BY THE ANNUAL TAX LEVY; ALL IN ORDER TO DO AND PERFORM ANY AND ALL OF THE MATTERS HEREINABOVE REFERRED TO FOR THE ACQUISITION, CONSTRUCTION AND COMPLETION OF AN EXHIBIT HALL, INCLUDING THE RELOCATION OF UTILITIES, ALL WITHIN THE CITY AND COUNTY; FIXING RATE OF INTEREST OF SAID BONDS AND PROVIDING FOR THE LEVY AND COLLECTION OF TAXES TO PAY BOTH PRINCIPAL AND INTEREST THEREOF, PRESCRIBING NOTICE TO BE GIVEN OF SUCH ELECTION AND CONSOLIDATING THE SPECIAL ELECTION WITH THE STATE GENERAL ELECTION.**

Be it ordained by the People of the City and County of San Francisco, as follows:

Section 1. A special election is hereby called and ordered to be held in the City and County of San Francisco on Tuesday, the 2d day of November, 1954, for the purpose of submitting to the electors of said city and county a proposition to incur a bonded indebtedness of the City and County of San Francisco in the principal amount of \$3,275,000 for the acquisition, construction and completion by the City and County of San Francisco of the following municipal improvement, to wit: An exhibit hall, consisting of a main floor and roof under the surface of the southerly one-half of the Civic Center Plaza, with access under Grove Street to the Civic Auditorium, with all other works, property, or structures necessary or convenient for

an exhibit hall, including the relocation of utilities, all within the City and County of San Francisco.

Section 2. The estimated cost of the municipal improvement described herein was fixed by the Board of Supervisors by Resolution No. 14581 (Series of 1939), passed by more than two-thirds of said board, and approved by the Acting Mayor in the sum of \$3,275,000, and such sum is, and was found by said resolution to be, too great to be paid out of the ordinary annual income and revenue of the city and county, in addition to the other annual expenses thereof or other funds derived from taxes levied for that purpose and will require an expenditure greater than the amount allowed therefor by the annual tax levy.

The method and manner of payment of the estimated cost of the municipal improvement described herein are by the issuance of bonds of the City and County of San Francisco in the principal amount specified in Section 1 hereof.

Section 3. The special election hereby called and ordered to be held shall be held and conducted and the votes thereat received and canvassed, and the returns thereof made and the result thereof ascertained, determined and declared as herein provided and in all particulars not herein recited said election shall be held according to the laws of the State of California providing for and governing elections in the City and County of San Francisco, and the polls for such election shall be and remain open during the time required by said laws.

Section 4. The said special election hereby called shall be and hereby is consolidated with the State General Election to be held Tuesday, November 2, 1954, and the voting precincts, polling places and officers of election for said State General Election be and the same are hereby adopted, established, designated and named, respectively, as the voting precincts, polling places and officers of election for said special election hereby called, and as specifically set forth, in the official publication, by the Registrar of Voters of precincts, polling places and election officers for the said State General Election.

The ballots to be used at said special election shall be the ballots to be used at said State General Election and reference is hereby made to the notice of election setting forth the voting precincts, polling places and officers of election by the Registrar of Voters for the State General Election to be published in the San Francisco Examiner on or about October 19, 1954.

Section 5. On the ballots to be used at such special election and on the voting machines used at said special election, in addition to any other matter required by law to be printed thereon, shall appear thereon the following:

"Exhibit Hall Bonds, 1954. To incur a bonded indebtedness in the sum of \$3,275,000 for the acquisition, construction and completion of an exhibit hall, including the relocation of utilities, all within the City and County of San Francisco."

To vote for the proposition where ballots are used, and to incur the bonded indebtedness to the amount of and for the purposes stated herein, stamp a cross (X) in the blank space to the right of the word "Yes." To vote against the proposition and thereby refuse to authorize the incurring of a bonded indebtedness to the amount of and for the purposes stated herein, stamp a cross (X) in the blank space to the right of the word "No."

Where voting machines are used at said special election the said voting machines shall be so arranged that any qualified elector may vote for the proposition by pulling down a lever over the word "Yes" under or near a statement of the proposed proposition appearing on cardboard,

paper or other material placed on the front of the machine and said act shall constitute a vote for the proposition, and by pulling down a lever over the word "No" under or near a statement of the proposed proposition appearing on cardboard, paper or other material placed on the front of the machine, shall constitute a vote against the proposition. Said voting machines and the preparation of the same shall comply in all respects with the provisions of law.

Section 6. If at such special election it shall appear that two-thirds of all the voters voting on said proposition voted in favor of and authorized the incurring of a bonded indebtedness for the purposes set forth in said proposition, then such proposition shall have been accepted by the electors, and bonds shall be issued to defray the cost of the municipal improvement described herein. Such bonds shall be of the form and character known as "serials," and shall bear interest at a rate not to exceed 6 per centum per annum, payable semiannually.

Section 7. For the purpose of paying the principal and interest on said bonds, the Board of Supervisors shall, at the time of fixing the general tax levy and in the manner for such general tax levy provided, levy and collect annually each year until such bonds are paid, or until there is a sum in the Treasury of said city and county set apart for that purpose to meet all sums coming due for the principal and interest on said bonds, a tax sufficient to pay the annual interest on such bonds as the same become due and also such part of the principal thereof as shall become due before the proceeds of a tax levied at the time for making the next general tax levy can be made available for the payment of such principal.

Section 8. This ordinance shall be published once a day for at least seven (7) days in the San Francisco Examiner, a newspaper published daily in the City and County of San Francisco, being the official newspaper of said city and county and such publication shall constitute notice of said election and no other notice of the election hereby called need be given.

Approved as to form.

DION R. HOLM, City Attorney.

Passed for Second Reading—Board of Supervisors, San Francisco, August 9, 1954.

Ayes: Supervisors Arnold, Carberry, Christopher, Ferdon, Halley, Lewis, McAteer, McCarty, McMahan, Mead.

Absent: Supervisor Dobbs.

DOMINIC J. BOCCABELLA, Acting Clerk.

Read Second Time and Finally Passed—Board of Supervisors, San Francisco, August 16, 1954.

Ayes: Supervisors Arnold, Christopher, Dobbs, Ferdon, Halley, McAteer, McCarty, McMahan, Mead.

Absent: Supervisors Carberry, Lewis.

I hereby certify that the foregoing ordinance was finally passed by the Board of Supervisors of the City and County of San Francisco.

DOMINIC J. BOCCABELLA, Acting Clerk.

Approved: August 18, 1954.

ELMER E. ROBINSON, Mayor.

## ARGUMENT FOR PROPOSITION "A"

### Bond Issue for Expansion of Civic Auditorium to Accommodate Current Space Needs

Approves expanding the facilities of the Civic Auditorium, which was built in 1914, to accommodate today's increased space demands. The \$3,275,000 necessary to complete the construction will be repaid to the city out of revenues over an estimated 15-year period.

The Civic Auditorium, with its present limited capacity, is currently making an average profit of \$60,000 per year. Upon completion of the expansion it is estimated the yearly profit will be increased to \$175,000.

The expansion will create a large exhibition and convention hall, extending under the civic center plaza, which is city-owned land. It will add an area of 144,000 square feet. This is more than double the space now available in Civic Auditorium.

It will make it possible for San Francisco to accommodate the large national conventions and industrial expositions which are now going to other major cities, and to keep those which have now outgrown our present facilities.

Between \$16,000,000 and \$32,000,000 of new money will be brought to San Francisco yearly as expenditures by the additional convention and trade visitors, it is estimated by San Francisco's Convention and Visitors Bureau.

The new money poured into San Francisco's business channels will support payrolls of industry, trade, and professions in every part of the city.

Proposition "A" is endorsed by business, labor, and the press, and is recommended by the City Planning Commission.

This argument is sponsored by:

"Dollars for San Francisco" Citizens Committee.

HENRY NORTH, Chairman.

GEORGE JOHNS, Co-Chairman.

A "Yes" vote on Proposition "A" is endorsed by:

San Francisco Chamber of Commerce;

San Francisco Downtown Association;

San Francisco Convention and Visitors Bureau;

San Francisco Central Labor Council.

Reginald H. Biggs.

On August 30, 1954, the Board of Supervisors authorized the foregoing argument for inclusion in the election pamphlet for November 2, 1954, by the following vote:

Ayes: Supervisors Arnold, Carberry, Christopher, Dobbs, Ferdon, Halley, McCarty, McMahon, Mead.

Absent: Supervisors Lewis, McAteer.

JOHN R. McGRATH, Clerk.

### CONTROLLER'S STATEMENT PURSUANT TO CHARTER SECTION 183

#### PROPOSITION "A"

Should the proposed \$3,275,000 Exhibit Hall Bonds, 1954, be authorized and when all bonds shall have been issued it is estimated that the average amount required annually for fifteen years to pay the interest thereon and redemption thereof will be approximately \$253,267. The Chief Administrative Officer reported that as a product of construction of the proposed facility, the estimated annual operating and maintenance cost would be \$75,000 which brings the total estimated annual cost to \$328,267. The Chief

Administrative Officer further reported that the estimated annual revenue from the proposed facility would be \$125,000, which would make the estimated annual tax requirements \$203,267. Based on the current assessment roll \$203,267 will be equivalent to one and six tenths cents in the tax rate for an average of 15 years.

HARRY D. ROSS, Controller.

## PROPOSITION B

**Recreation Center Bonds, 1954. To incur a bonded indebtedness in the sum of \$5,000,000 for the acquisition, construction and completion of buildings, lands and other works and properties to be used for baseball, football, other sports, dramatic productions and other lawful uses as a recreation center.**

## PROPOSITION B

File No. 11855-1

Ordinance No. 8733

(Series of 1939)

**CALLING AND PROVIDING FOR A SPECIAL ELECTION TO BE HELD IN THE CITY AND COUNTY OF SAN FRANCISCO ON TUESDAY, NOVEMBER 2, 1954, FOR THE PURPOSE OF SUBMITTING TO THE VOTERS OF THE CITY AND COUNTY OF SAN FRANCISCO A PROPOSITION TO INCUR A BONDED DEBT OF THE CITY AND COUNTY TO THE AMOUNT OF \$5,000,000 FOR THE ACQUISITION, CONSTRUCTION AND COMPLETION BY THE CITY AND COUNTY OF SAN FRANCISCO OF THE FOLLOWING MUNICIPAL IMPROVEMENT, TO WIT: A RECREATION CENTER WHEREIN, BASEBALL, FOOTBALL OR ANY OTHER FORM OF SPORT ADAPTABLE MAY BE ENGAGED IN WITHIN SAID CENTER, PAGEANTRY, DRAMATIC PRODUCTIONS, PLACE OF ASSEMBLAGE FOR ANY LAWFUL PURPOSE, OR ANY OTHER LAWFUL USES WHICH THE CENTER IS CAPABLE OF ACCOMMODATING; THE ACQUISITION OF LANDS, CONSTRUCTION OF BUILDINGS, PLAYFIELDS, LIGHTING APPARATUS, AND ALL OTHER WORKS, PROPERTIES, STRUCTURES OR APPURTENANCES NECESSARY OR CONVENIENT FOR A RECREATION CENTER WITHIN THE CITY AND COUNTY OF SAN FRANCISCO, AND THAT THE ESTIMATED COST TO THE CITY AND COUNTY OF SAID MUNICIPAL IMPROVEMENT IS AND WILL BE TOO GREAT TO BE PAID OUT OF THE ORDINARY ANNUAL INCOME AND REVENUE OF THE CITY AND COUNTY AND WILL REQUIRE AN EXPENDITURE GREATER THAN THE AMOUNT ALLOWED THEREFOR BY THE ANNUAL TAX LEVY; ALL IN ORDER TO DO AND PERFORM ANY AND ALL OF THE MATTERS HEREINABOVE REFERRED TO FOR THE ACQUISITION, CONSTRUCTION AND COMPLETION OF A RECREATION CENTER WITHIN THE CITY AND COUNTY OF SAN FRANCISCO, AND ALL OTHER WORKS, PROPERTIES OR STRUCTURES AS ABOVE DESCRIBED; FIXING RATE OF INTEREST OF SAID BONDS AND PROVIDING FOR THE LEVY AND COLLECTION OF TAXES TO PAY BOTH PRINCIPAL AND INTEREST THEREOF, PRESCRIBING NOTICE TO BE GIVEN OF SUCH ELECTION AND CONSOLIDATING THE SPECIAL ELECTION WITH THE STATE GENERAL ELECTION.**

Be it ordained by the People of the City and County of San Francisco, as follows:

Section 1. A special election is hereby called and ordered to be held in the City and County of San Francisco on Tuesday, the 2d day of November, 1954, for the purpose of submitting to the electors of said city and county a proposition to incur a bonded indebtedness of the City and County of San Francisco in the principal amount of \$5,000,000 for the acquisition, construction and completion by the City and County of San Francisco of the following municipal improvement, to wit: A recreation center wherein baseball, football or any other form of sport adaptable may be engaged in within said center, pageantry, dramatic productions, place of assemblage for any lawful purpose, or any other lawful uses which the center is capable of accommodating; the acquisition of lands, construction of buildings, playfields, lighting apparatus, and all other works, properties, structures or appurtenances necessary or convenient for a recreation center within the City and County of San Francisco.

Section 2. The estimated cost of the municipal improvement described herein was fixed by the Board of Supervisors by Resolution No. 14579 (Series of 1939), passed by more than two-thirds of said board, and approved by the Acting Mayor in the sum of \$5,000,000, and such sum is, and was found by said resolution to be, too great to be paid out of the ordinary annual income and revenue of the city and county, in addition to the other annual expenses thereof or other funds derived from taxes levied for that purpose and will require an expenditure greater than the amount allowed therefor by the annual tax levy.

The method and manner of payment of the estimated cost of the municipal improvement described herein are by the issuance of bonds of the City and County of San Francisco in the principal amount specified in Section 1 hereof.

Section 3. The special election hereby called and ordered to be held shall be held and conducted and the votes thereat received and canvassed, and the returns thereof made and the result thereof ascertained, determined and declared as herein provided and in all particulars not herein recited said election shall be held according to the laws of the State of California providing for and governing elections in the City and County of San Francisco, and the polls for such election shall be and remain open during the time required by said laws.

Section 4. The said special election hereby called shall be and hereby is consolidated with the State General Election to be held Tuesday, November 2, 1954, and the voting precincts, polling places and officers of election for said State General Election be and the same are hereby adopted, established, designated and named, respectively, as the voting precincts, polling places and officers of election for said special election hereby called, and as specifically set forth, in the official publication, by the Registrar of Voters of precincts, polling places and election officers for the said State General Election.

The ballots to be used at said special election shall be the ballots to be used at said State General Election and reference is hereby made to the notice of election setting forth the voting precincts, polling places and officers of election by the Registrar of Voters for the State General Election to be published in the San Francisco Examiner on or about October 19, 1954.

Section 5. On the ballots to be used at such special election and on the voting machines used at said special election, in addition to any other matter required by law to be printed thereon, shall appear thereon the following:

"Recreation Center Bonds, 1954. To incur a bonded indebtedness in the sum of \$5,000,000 for the acquisition, construction and completion of buildings, lands and other works and properties to be used for baseball, football, other sports, dramatic productions and other lawful uses as a recreation center."

To vote for the proposition where ballots are used, and to incur the bonded indebtedness to the amount of and for the purposes stated herein, stamp a cross (X) in the blank space to the right of the word "Yes." To vote against the proposition and thereby refuse to authorize the incurring of a bonded indebtedness to the amount of and for the purposes stated herein, stamp a cross (X) in the blank space to the right of the word "No."

Where voting machines are used at said special election the said voting machines shall be so arranged that any qualified elector may vote for the proposition by pulling down a lever over the word "Yes" under or near a statement of the proposed proposition appearing on cardboard, paper or other material placed on the front of the machine and said act shall constitute a vote for the proposition, and by pulling down a lever over the word "No" under or near a statement of the proposed proposition appearing on cardboard, paper or other material placed on the front of the machine, shall constitute a vote against the proposition. Said voting machines and the preparation of the same shall comply in all respects with the provisions of law.

Section 6. If at such special election it shall appear that two-thirds of all the voters voting on said proposition voted in favor of and authorized the incurring of a bonded indebtedness for the purposes set forth in said proposition, then such proposition shall have been accepted by the electors, and bonds shall be issued to defray the cost of the municipal improvement described herein. Such bonds shall be of the form and character known as "serials," and shall bear interest at a rate not to exceed 6 per centum per annum, payable semiannually.

Section 7. For the purpose of paying the principal and interest on said bonds, the Board of Supervisors shall, at the time of fixing the general tax levy and in the manner for such general tax levy provided, levy and collect annually each year until such bonds are paid, or until there is a sum in the Treasury of said city and county set apart for that purpose to meet all sums coming due for the principal and interest on said bonds, a tax sufficient to pay the annual interest on such bonds as the same become due and also such part of the principal thereof as shall become due before the proceeds of a tax levied at the time for making the next general tax levy can be made available for the payment of such principal.

Section 8. This ordinance shall be published once a day for at least seven (7) days in the San Francisco Examiner, a newspaper published daily in the City and County of San Francisco, being the official newspaper of said city and county and such publication shall constitute notice of said election and no other notice of the election hereby called need be given.

Approved as to form.

DION R. HOLM, City Attorney.

Passed for Second Reading—Board of Supervisors, San Francisco, August 9, 1954.

Ayes: Supervisors Arnold, Carberry, Christopher, Ferdon, Halley, Lewis, McAteer, McCarty, McMahan, Mead.

Absent: Supervisor Dobbs.

DOMINIC J. BOCCABELLA, Acting Clerk.

Read Second Time and Finally Passed—Board of Supervisors, San Francisco, August 16, 1954.

**Ayes:** Supervisors Arnold, Christopher, Dobbs, Ferdon, Halley, McAteer, McCarty, McMahon, Mead.

**Absent:** Supervisors Carberry, Lewis.

I hereby certify that the foregoing ordinance was finally passed by the Board of Supervisors of the City and County of San Francisco.

DOMINIC J. BOCCABELLA, Acting Clerk.

Approved: August 18, 1954.

ELMER E. ROBINSON, Mayor.

### **ARGUMENT FOR PROPOSITION "B"**

#### **Bond Issue for Recreation Center Stadium for Major League Baseball and Other Uses**

The San Francisco Board of Supervisors unanimously approved this proposal and referred Proposition "B" to a vote of the people because of its importance to our future prosperity.

A committee of distinguished San Francisco community leaders has been appointed by His Honor, Mayor Elmer E. Robinson, to organize a campaign on behalf of Proposition "B."

Proposition "B" is supported by the San Francisco press and major civic and community bodies devoted to the welfare and prosperity of our city.

Proposition "B" is a \$5,000,000 Recreation Center Stadium bond proposal. It is designed to put additional dollars in every San Francisco pocket and cash register.

Proposition "B" is intended to provide proper facilities for major league baseball, major league football, title fights, and other major outdoor sports activities as well as pageants, dramatic spectacles, religious convocations and other "lawful uses." Vote yes.

Last year an additional \$5,000,000 was brought into Milwaukee, Wisconsin by out of town visitors when its new municipally-built stadium was made available for major league baseball.

According to recent surveys, some 300,000 out of town fans and tourists from all parts of Northern California, Oregon, Washington and Nevada may be expected to spend additional dollars in San Francisco during a major league baseball season—if Proposition "B" receives a YES vote.

How will the Recreation Center Stadium bonds be amortized?

It is planned to amortize them through using a portion of the admission charges and concession sales. In less than 20 years the bond obligations should be completely paid for by those making use of the facility.

Moreover, not one cent of the issue will be spent until a definite major league franchise has been obtained. If negotiations are not completed within five years for such a franchise, the bonds will not be sold. Vote yes.

Aside from the purely monetary considerations, the Recreation Center Stadium proposal will aid in the fight against juvenile delinquency, by offering an additional outlet for youth. Vote yes.

It will provide for San Franciscans, already proud of living in one of the world's greatest cities, the opportunity to take additional pride in being a resident of one of the few American cities that is truly "big league" all the way.

Proposition "B" deserves an overwhelming YES vote because: It is expected to bring major league baseball to San Francisco. It will provide a badly needed Recreation Center and Stadium for a multitude of sports, dramatic spectacles for pageants. It will enhance San Francisco's reputation as a mecca for sports fans and tourists.

Through a YES vote on "B," thousands of additional dollars will annually flow through San Francisco business and employee channels, thus adding to the prosperity of all. Proposition "B" should be approved.

Vote YES on "B."

On August 30, 1954, the Board of Supervisors authorized the foregoing argument for inclusion in the election pamphlet for November 2, 1954, by the following vote:

Ayes: Supervisors Arnold, Carberry, Christopher, Dobbs, Ferdon, Halley, McCarty, McMahon, Mead.

Absent: Supervisors Lewis, McAteer.

JOHN R. McGRATH, Clerk.

## CONTROLLER'S STATEMENT PURSUANT TO CHARTER SECTION 183

### PROPOSITION "B"

Should the proposed \$5,000,000 Recreation Center Bonds, 1954, be authorized and when all bonds shall have been issued it is estimated that the average amount required annually for fifteen years to pay the interest thereon and redemption thereof will be approximately \$386,667. Based on the current assessment roll, \$386,667 will be equivalent to three and one tenths cents in the tax rate for an average of fifteen years. Based on reports received from other cities which have recently completed a recreation center and permitted its use for major league baseball, it is our judgment that, after paying the costs of operation and maintenance, the total amount of bonds proposed in proposition "B" plus the total cost of interest thereon would be returned in approximately twenty-five years.

HARRY D. ROSS, Controller.

### PROPOSITION C

**San Francisco Hospital Bonds, 1954. To incur a bonded indebtedness in the sum of \$5,830,000 for the acquisition, construction and completion of buildings, lands, roadways, parking areas, utilities, and all other works, properties or structures necessary or convenient for the improvement of the San Francisco Hospital.**

### PROPOSITION C

File No. 11920-3

Ordinance No. 8734

(Series of 1939)

**CALLING AND PROVIDING FOR A SPECIAL ELECTION TO BE HELD IN THE CITY AND COUNTY OF SAN FRANCISCO ON TUESDAY, NOVEMBER 2, 1954, FOR THE PURPOSE OF SUBMITTING TO THE VOTERS OF THE CITY AND COUNTY OF SAN FRANCISCO A PROPOSITION TO INCUR A BONDED DEBT OF THE CITY AND COUNTY TO THE AMOUNT OF \$5,830,000 FOR THE ACQUISITION, CONSTRUCTION AND COMPLETION BY THE CITY AND COUNTY OF SAN FRANCISCO OF THE FOLLOWING MUNICIPAL IMPROVEMENT, TO WIT: IMPROVEMENT OF THE SAN FRANCISCO HOSPITAL AND OF BUILDINGS AND LANDS CONNECTED THEREWITH, INCLUDING ADDITIONS AND BETTERMENTS OF EXISTING STRUCTURES, NEW STRUCTURES, IMPROVEMENT OF HOSPITAL FACILITIES, ROADWAYS, PARKING AREAS, ELECTRIC, WATER, PLUMBING AND SEWAGE FACILITIES, AND ALL**

**OTHER WORKS, PROPERTIES OR STRUCTURES NECESSARY OR CONVENIENT FOR THE IMPROVEMENT OF THE SAN FRANCISCO HOSPITAL, ALL WITHIN THE CITY AND COUNTY OF SAN FRANCISCO, AND THAT THE ESTIMATED COST TO THE CITY AND COUNTY OF SAID MUNICIPAL IMPROVEMENT IS AND WILL BE TOO GREAT TO BE PAID OUT OF THE ORDINARY ANNUAL INCOME AND REVENUE OF THE CITY AND COUNTY AND WILL REQUIRE AN EXPENDITURE GREATER THAN THE AMOUNT ALLOWED THEREFOR BY THE ANNUAL TAX LEVY; ALL IN ORDER TO DO AND PERFORM ANY AND ALL OF THE MATTERS HEREINABOVE REFERRED TO FOR THE IMPROVEMENT OF THE SAN FRANCISCO HOSPITAL AND OF BUILDINGS, LANDS, ROADWAYS, PARKING AREAS, UTILITIES, AND ALL OTHER WORKS, PROPERTIES OR STRUCTURES AS ABOVE DESCRIBED; FIXING RATE OF INTEREST OF SAID BONDS AND PROVIDING FOR THE LEVY AND COLLECTION OF TAXES TO PAY BOTH PRINCIPAL AND INTEREST THEREOF, PRESCRIBING NOTICE TO BE GIVEN OF SUCH ELECTION AND CONSOLIDATING THE SPECIAL ELECTION WITH THE STATE GENERAL ELECTION.**

Be it ordained by the People of the City and County of San Francisco, as follows:

Section 1. A special election is hereby called and ordered to be held in the City and County of San Francisco on Tuesday, the 2d day of November, 1954, for the purpose of submitting to the electors of said city and county a proposition to incur a bonded indebtedness of the City and County of San Francisco in the principal amount of \$5,830,000 for the acquisition, construction and completion by the City and County of San Francisco of the following municipal improvement, to wit: Improvement of the San Francisco Hospital and of buildings and lands connected therewith, including additions and betterments of existing structures, new structures, improvement of hospital facilities, roadways, parking areas, electric, water, plumbing and sewage facilities, and all other works, properties or structures necessary or convenient for the improvement of the San Francisco Hospital, all within the City and County of San Francisco.

Section 2. The estimated cost of the municipal improvement described herein was fixed by the Board of Supervisors by Resolution No. 14580 (Series of 1939), passed by more than two-thirds of said board, and approved by the Acting Mayor in the sum of \$5,830,000, and such sum is, and was found by said resolution to be, too great to be paid out of the ordinary annual income and revenue of the city and county, in addition to the other annual expenses thereof or other funds derived from taxes levied for that purpose and will require an expenditure greater than the amount allowed therefor by the annual tax levy.

The method and manner of payment of the estimated cost of the municipal improvement described herein are by the issuance of bonds of the City and County of San Francisco in the principal amount specified in Section 1 hereof.

Section 3. The special election hereby called and ordered to be held shall be held and conducted and the votes thereat received and canvassed; and the returns thereof made and the result thereof ascertained, determined and declared as herein provided and in all particulars not herein recited said election shall be held according to the laws of the State of California providing for and governing elections in the City and County of San Francisco, and the polls for such election shall be and remain open during the time required by said laws.

**Section 4.** The said special election hereby called shall be and hereby is consolidated with the State General Election to be held Tuesday, November 2, 1954, and the voting precincts, polling places and officers of election for said State General Election be and the same are hereby adopted, established, designated and named, respectively, as the voting precincts, polling places and officers of election for said special election hereby called, and as specifically set forth, in the official publication, by the Registrar of Voters of precincts, polling places and election officers for the said State General Election.

The ballots to be used at said special election shall be the ballots to be used at said State General Election and reference is hereby made to the notice of election setting forth the voting precincts, polling places and officers of election by the Registrar of Voters for the State General Election to be published in the San Francisco Examiner on or about October 19, 1954.

**Section 5.** On the ballots to be used at such special election and on the voting machines used at said special election, in addition to any other matter required by law to be printed thereon, shall appear thereon the following:

"San Francisco Hospital Bonds, 1954. To incur a bonded indebtedness in the sum of \$5,830,000 for the acquisition, construction and completion of buildings, lands, roadways, parking areas, utilities, and all other works, properties or structures necessary or convenient for the improvement of the San Francisco Hospital."

To vote for the proposition where ballots are used, and to incur the bonded indebtedness to the amount of and for the purposes stated herein, stamp a cross (X) in the blank space to the right of the word "Yes." To vote against the proposition and thereby refuse to authorize the incurring of a bonded indebtedness to the amount of and for the purposes stated herein, stamp a cross (X) in the blank space to the right of the word "No."

Where voting machines are used at said special election the said voting machines shall be so arranged that any qualified elector may vote for the proposition by pulling down a lever over the word "Yes" under or near a statement of the proposed proposition appearing on cardboard, paper or other material placed on the front of the machine and said act shall constitute a vote for the proposition, and by pulling down a lever over the word "No" under or near a statement of the proposed proposition appearing on cardboard, paper or other material placed on the front of the machine, shall constitute a vote against the proposition. Said voting machines and the preparation of the same shall comply in all respects with the provisions of law.

**Section 6.** If at such special election it shall appear that two-thirds of all the voters voting on said proposition voted in favor of and authorized the incurring of a bonded indebtedness for the purposes set forth in said proposition, then such proposition shall have been accepted by the electors, and bonds shall be issued to defray the cost of the municipal improvement described herein. Such bonds shall be of the form and character known as "serials," and shall bear interest at a rate not to exceed 6 per centum per annum, payable semiannually.

**Section 7.** For the purpose of paying the principal and interest on said bonds, the Board of Supervisors shall, at the time of fixing the general tax levy and in the manner for such general tax levy provided, levy and collect annually each year until such bonds are paid, or until there is a sum in the Treasury of said city and county set apart for that purpose to meet all sums coming due for the principal and interest on said bonds, a tax sufficient to pay the annual interest on such bonds as the same become due and also such

part of the principal thereof as shall become due before the proceeds of a tax levied at the time for making the next general tax levy can be made available for the payment of such principal.

Section 8. This ordinance shall be published once a day for at least seven (7) days in the San Francisco Examiner, a newspaper published daily in the City and County of San Francisco, being the official newspaper of said city and county and such publication shall constitute notice of said election and no other notice of the election hereby called need be given.

Approved as to form.

DION R. HOLM, City Attorney.

Passed for Second Reading—Board of Supervisors, San Francisco, August 9, 1954.

Ayes: Supervisors Arnold, Carberry, Christopher, Ferdon, Halley, Lewis, McAteer, McCarty, McMahan, Mead.

Absent: Supervisor Dobbs.

DOMINIC J. BOCCABELLA, Acting Clerk.

Read Second Time and Finally Passed—Board of Supervisors, San Francisco, August 16, 1954.

Ayes: Supervisors Arnold, Christopher, Dobbs, Ferdon, Halley, McAteer, McCarty, McMahan, Mead.

Absent: Supervisors Carberry, Lewis.

I hereby certify that the foregoing ordinance was finally passed by the Board of Supervisors of the City and County of San Francisco.

DOMINIC J. BOCCABELLA, Acting Clerk.

Approved: August 18, 1954.

ELMER E. ROBINSON, Mayor.

## ARGUMENT FOR PROPOSITION "C"

### San Francisco Hospital Bonds

Vote "YES" on Proposition "C"—to safeguard the health of the people of San Francisco by improving and expanding the facilities at San Francisco Hospital.

A "YES" vote will provide funds to modernize this run-down physical plant by bringing the water, steam, and electrical circuits up to date. It will enable us to provide modern, efficient admitting services, emergency care facilities, and nursing stations on the wards.

A "YES" vote will enable the hospital to better comply with the fire and safety requirements, and to make better use of our personnel by the addition of modern communication systems, new elevators, and additional kitchen and storage facilities designed for present-day needs.

Vote "YES"—to improve our services for the care of the mentally ill, the tuberculous, and to all our indigent sick, by providing modern laboratory facilities for early diagnosis and more effective therapy by providing better facilities for leading and training doctors and nurses, and by generally improving efficiency.

Vote "YES" on Proposition "C"—so that San Francisco Hospital can meet the demands for modern medical and hospital care affecting the lives of more than two thousand patients each month.

Vote "YES"—with many others who realize that modern facilities at San Francisco Hospital will be reflected in improved health of the people of San Francisco. Remember, it may be YOU who will some day be needing these services.

Vote "YES" on Proposition "C"—and support your Health Department, the Board of Supervisors, the Chief Administrative Officer, the County

Medical Society, the Health Advisory Board, and labor and business who have studied and approved this Bond Issue.

On August 30, 1954, the Board of Supervisors authorized the foregoing argument for inclusion in the election pamphlet for November 2, 1954, by the following vote:

Ayes: Supervisors Arnold, Carberry, Christopher, Dobbs, Ferdon, Halley, McCarty, McMahan, Mead.

Absent: Supervisors Lewis, McAteer.

JOHN R. McGRATH, Clerk.

CONTROLLER'S STATEMENT PURSUANT TO CHARTER  
SECTION 183

PROPOSITION "C"

Should the proposed \$5,830,000 Hospital Bonds, 1954, be authorized and when all bonds shall have been issued it is estimated that the average amount required annually for fifteen years to pay the interest thereon and redemption thereof will be approximately \$450,853. The Chief Administrative Officer reported that as a product of the expenditure of \$5,830,000 the estimated annual operation and maintenance expense would decrease \$30,000. Based on the current assessment roll the net annual cost of \$420,853 will be equivalent to three and four tenths cents in the tax rate.

HARRY D. ROSS, Controller.

PROPOSITION D

**Laguna Honda Home and Hospital Bonds, 1954. To incur a bonded indebtedness in the sum of \$5,475,000 for the acquisition, construction and completion of buildings, lands, structures, and all other works or properties necessary or useful for additions and betterment to and rehabilitation of Laguna Honda Home and Hospital.**

PROPOSITION D

File No. 10486-6

Ordinance No. 8732

(Series of 1939)

**CALLING AND PROVIDING FOR A SPECIAL ELECTION TO BE HELD IN THE CITY AND COUNTY OF SAN FRANCISCO ON TUESDAY, NOVEMBER 2, 1954, FOR THE PURPOSE OF SUBMITTING TO THE VOTERS OF THE CITY AND COUNTY OF SAN FRANCISCO A PROPOSITION TO INCUR A BONDED DEBT OF THE CITY AND COUNTY TO THE AMOUNT OF \$5,475,000 FOR THE ACQUISITION, CONSTRUCTION AND COMPLETION BY THE CITY AND COUNTY OF SAN FRANCISCO OF THE FOLLOWING MUNICIPAL IMPROVEMENT, TO WIT: BUILDINGS, LANDS, STRUCTURES, AND ALL OTHER WORKS, PROPERTIES AND APPURTENANCES NECESSARY OR USEFUL FOR THE EXTENSION AND REHABILITATION OF LAGUNA HONDA HOME AND HOSPITAL, THE REHABILITATION, REPLACEMENT, ADDITIONS AND BETTERMENTS OF EXISTING STRUCTURES AND THE ACQUISITION OF NEW STRUCTURES, ROADWAYS, ELECTRIC AND WATER DISTRIBUTION SYSTEMS, AND ALL OTHER WORKS OR PROPERTIES NECESSARY OR USEFUL FOR THE REHABILITATION OF LAGUNA HONDA HOME AND HOSPITAL, ALL WITHIN THE CITY AND COUNTY OF SAN FRANCISCO, AND THAT THE ESTIMATED**

**COST TO THE CITY AND COUNTY OF SAID MUNICIPAL IMPROVEMENT IS AND WILL BE TOO GREAT TO BE PAID OUT OF THE ORDINARY ANNUAL INCOME AND REVENUE OF THE CITY AND COUNTY AND WILL REQUIRE AN EXPENDITURE GREATER THAN THE AMOUNT ALLOWED THEREFOR BY THE ANNUAL TAX LEVY; ALL IN ORDER TO DO AND PERFORM ANY AND ALL OF THE MATTERS HEREINABOVE REFERRED TO FOR THE EXTENSION AND REHABILITATION OF LAGUNA HONDA HOME AND HOSPITAL, AND ALL OTHER WORKS, PROPERTIES OR STRUCTURES AS ABOVE DESCRIBED; FIXING RATE OF INTEREST OF SAID BONDS AND PROVIDING FOR THE LEVY AND COLLECTION OF TAXES TO PAY BOTH PRINCIPAL AND INTEREST THEREOF, PRESCRIBING NOTICE TO BE GIVEN OF SUCH ELECTION AND CONSOLIDATING THE SPECIAL ELECTION WITH THE STATE GENERAL ELECTION.**

Be it ordained by the People of the City and County of San Francisco, as follows:

Section 1. A special election is hereby called and ordered to be held in the City and County of San Francisco on Tuesday, the 2d day of November, 1954, for the purpose of submitting to the electors of said city and county a proposition to incur a bonded indebtedness of the City and County of San Francisco in the principal amount of \$5,475,000 for the acquisition, construction and completion by the City and County of San Francisco of the following municipal improvement, to wit: Buildings, lands, structures, and all other works, properties and appurtenances necessary or useful for the extension and rehabilitation of Laguna Honda Home and Hospital, the rehabilitation, replacement, additions and betterments of existing structures and the acquisition of new structures, roadways, electric and water distribution systems, and all other works or properties necessary or useful for the rehabilitation of Laguna Honda Home and Hospital, all within the City and County of San Francisco.

Section 2. The estimated cost of the municipal improvement described herein was fixed by the Board of Supervisors by Resolution No. 14578 (Series of 1939), passed by more than two-thirds of said board, and approved by the Acting Mayor in the sum of \$5,475,000, and such sum is, and was found by said resolution to be, too great to be paid out of the ordinary annual income and revenue of the city and county, in addition to the other annual expenses thereof or other funds derived from taxes levied for that purpose and will require an expenditure greater than the amount allowed therefor by the annual tax levy.

The method and manner of payment of the estimated cost of the municipal improvement described herein are by the issuance of bonds of the City and County of San Francisco in the principal amount specified in Section 1 hereof.

Section 3. The special election hereby called and ordered to be held shall be held and conducted and the votes thereat received and canvassed, and the returns thereof made and the result thereof ascertained, determined and declared as herein provided and in all particulars not herein recited said election shall be held according to the laws of the State of California providing for and governing elections in the City and County of San Francisco, and the polls for such election shall be and remain open during the time required by said laws.

Section 4. The said special election hereby called shall be and hereby is consolidated with the State General Election to be held Tuesday, November 2, 1954, and the voting precincts, polling places and officers of election

for said State General Election be and the same are hereby adopted, established, designated and named, respectively, as the voting precincts, polling places and officers of election for said special election hereby called, and as specifically set forth, in the official publication, by the Registrar of Voters of precincts, polling places and election officers for the said State General Election.

The ballots to be used at said special election shall be the ballots to be used at said State General Election and reference is hereby made to the notice of election setting forth the voting precincts, polling places and officers of election by the Registrar of Voters for the State General Election to be published in the San Francisco Examiner on or about October 19, 1954.

Section 5. On the ballots to be used at such special election and on the voting machines used at said special election, in addition to any other matter required by law to be printed thereon, shall appear thereon the following:

"Laguna Honda Home and Hospital Bonds, 1954. To incur a bonded indebtedness in the sum of \$5,475,000 for the acquisition, construction and completion of buildings, lands, structures, and all other works or properties necessary or useful for additions and betterment to and rehabilitation of Laguna Honda Home and Hospital."

To vote for the proposition where ballots are used, and to incur the bonded indebtedness to the amount of and for the purposes stated herein, stamp a cross (X) in the blank space to the right of the word "Yes." To vote against the proposition and thereby refuse to authorize the incurring of a bonded indebtedness to the amount of and for the purposes stated herein, stamp a cross (X) in the blank space to the right of the word "No."

Where voting machines are used at said special election the said voting machines shall be so arranged that any qualified elector may vote for the proposition by pulling down a lever over the word "Yes" under or near a statement of the proposed proposition appearing on cardboard, paper or other material placed on the front of the machine and said act shall constitute a vote for the proposition, and by pulling down a lever over the word "No" under or near a statement of the proposed proposition appearing on cardboard, paper or other material placed on the front of the machine, shall constitute a vote against the proposition. Said voting machines and the preparation of the same shall comply in all respects with the provisions of law.

Section 6. If at such special election it shall appear that two-thirds of all the voters voting on said proposition voted in favor of and authorized the incurring of a bonded indebtedness for the purposes set forth in said proposition, then such proposition shall have been accepted by the electors, and bonds shall be issued to defray the cost of the municipal improvement described herein. Such bonds shall be of the form and character known as "serials," and shall bear interest at a rate not to exceed 6 per centum per annum, payable semiannually.

Section 7. For the purpose of paying the principal and interest on said bonds, the Board of Supervisors shall, at the time of fixing the general tax levy and in the manner for such general tax levy provided, levy and collect annually each year until such bonds are paid, or until there is a sum in the Treasury of said city and county set apart for that purpose to meet all sums coming due for the principal and interest on said bonds, a tax sufficient to pay the annual interest on such bonds as the same become due and also such part of the principal thereof as shall become due before the proceeds of a tax levied at the time for making the next general tax levy can be made available for the payment of such principal.

**Section 8.** This ordinance shall be published once a day for at least seven (7) days in the San Francisco Examiner, a newspaper published daily in the City and County of San Francisco, being the official newspaper of said city and county and such publication shall constitute notice of said election and no other notice of the election hereby called need be given.

Approved as to form.

DION R. HOLM, City Attorney.

Passed for Second Reading—Board of Supervisors, San Francisco, August 9, 1954.

Ayes: Supervisors Arnold, Carberry, Christopher, Ferdon, Halley, Lewis, McAteer, McCarty, McMahan, Mead.

Absent: Supervisor Dobbs.

DOMINIC J. BOCCABELLA, Acting Clerk.

Read Second Time and Finally Passed—Board of Supervisors, San Francisco, August 16, 1954.

Ayes: Supervisors Arnold, Christopher, Dobbs, Ferdon, Halley, McAteer, McCarty, McMahan, Mead.

Absent: Supervisors Carberry, Lewis.

I hereby certify that the foregoing ordinance was finally passed by the Board of Supervisors of the City and County of San Francisco.

DOMINIC J. BOCCABELLA, Acting Clerk.

Approved: August 18, 1954.

ELMER E. ROBINSON, Mayor.

## ARGUMENT FOR PROPOSITION "D"

### Laguna Honda Home Bonds

Vote "YES" on Proposition "D"—to prove that San Francisco is the "City that Knows How" to take care of its aging and chronically ill people.

Vote "YES"—so that we may modernize our deteriorated home and hospital, provide modern facilities for diagnosis, therapy, and rehabilitation, and give our elderly people a more cheerful place in which to spend their declining years.

Vote "YES" to provide much-needed additional beds for hospital patients. These funds will provide 305 additional hospital beds for the chronically ill, to a total of 1213 hospital beds; the facilities for the ambulatory inmates will be decreased from 1134 to 864. This is in line with the increased needs for beds for the sick.

Vote "YES" on Proposition "D"—Join with the Board of Supervisors, the Chief Administrative Officer, the Health Department, the Health Advisory Board, the County Medical Society, the Mayor's Bond Screening Committee and many other groups and organizations interested in protecting our facilities, and increasing our investment in service to humanity by modernizing this important part of Health Department services to the people of San Francisco.

On August 30, 1954, the Board of Supervisors authorized the foregoing argument for inclusion in the election pamphlet for November 2, 1954, by the following vote:

Ayes: Supervisors Arnold, Carberry, Christopher, Dobbs, Ferdon, Halley, McCarty, McMahan, Mead.

Absent: Supervisors Lewis, McAteer.

JOHN R. McGRATH, Clerk.

CONTROLLER'S STATEMENT PURSUANT TO CHARTER  
SECTION 183

**PROPOSITION "D"**

Should the proposed \$5,475,000 Laguna Honda Home and Hospital Rehabilitation Bonds, 1954, be authorized and when all bonds shall have been issued it is estimated that the average amount required annually for fifteen years to pay the interest thereon and redemption thereof will be approximately \$423,400. The Chief Administrative Officer reported that as a product of the expenditure of \$5,475,000, the estimated annual decrease in operations and maintenance expense would be \$75,000. Based on the current assessment roll, the net annual cost of \$348,400 will be equivalent to two and eight tenths cents in the tax rate.

HARRY D. ROSS, Controller.

**PROPOSITION E**

**Adds Charter Section 145.02; declares policy to encourage hiring qualified blind persons in city service on equal opportunity with sighted persons; requires classification of positions, conduct of examinations and appointment accordingly.**

**CHARTER AMENDMENT  
PROPOSITION "E"**

Describing and setting forth a proposal to the qualified electors of the City and County of San Francisco to amend the charter of said city and county by adding thereto Section 145.02, relating to the employment of blind persons in the public service.

The Board of Supervisors of the City and County of San Francisco hereby submits to the qualified electors of said city and county at an election to be held therein on November 2, 1954, a proposal to amend the charter of said city and county by adding Section 145.02 thereto, reading as follows:

Note: Additions indicated by bold-face type.

**EMPLOYMENT OF BLIND PERSONS**

**Section 145.02.** Notwithstanding anything to the contrary in Section 140 of this charter, or any other provision of the charter, it shall be the policy of the City and County of San Francisco, consistent with a policy of acquiring qualified personnel for the service of the city and county, to encourage the hiring of blind persons. It shall further be the policy of the City and County of San Francisco that no otherwise qualified blind person shall be discriminated against in examination, re-examination, appointment, reappointment, waiver of eligibility for appointment or reappointment, promotion or demotion in any class, subclass or position in the civil service unless eyesight is indispensable for the performance of the duties and responsibilities of the class, subclass or position. It shall be the duty of the commission to classify, and from time to time may reclassify, places of employment in the civil service the duties of which may be efficiently performed by qualified blind persons and to conduct appropriate examinations which will fairly test the capacity of blind persons as well as sighted persons to perform such duties.

Ordered submitted: Board of Supervisors, San Francisco, August 2, 1954.

Ayes: Supervisors Arnold, Carberry, Christopher, Dobbs, Ferdon, Halley, Lewis, McAteer, McCarty, McMahan, Mead.

I hereby certify that the foregoing charter amendment was ordered submitted by the Board of Supervisors of the City and County of San Francisco.

JOHN R. McGRATH, Clerk.

### ARGUMENT FOR PROPOSITION "E"

#### Vote Yes on Proposition "E"

Proposition "E" ends discrimination by which competent blind citizens of San Francisco have been excluded from City employment in spite of their proven ability to serve efficiently.

Proposition "E" results not only in a saving but also as a gain to San Francisco. Public money is now spent to support blind persons who are able and want to work if civil service discriminations are removed.

Proposition "E" gives the blind equal opportunity. It does not give them special preference. It does not create jobs. Rather, it provides for the classification of existing jobs which can be efficiently performed by qualified blind persons. The sighted are not kept from competing for these jobs.

Proposition "E" is based on the State law which forbids discrimination against the employment of qualified blind persons in State civil service positions unless eyesight is necessary.

Proposition "E" was passed by the Judiciary Committee of the Board of Supervisors, reviewed and upheld by the City Attorney, and ordered on the ballot by unanimous vote of the Board of Supervisors.

The San Francisco County Club of Adult Blind and the California Council for the Blind recommend a "YES" vote on Proposition "E."

Vote "YES" on Proposition "E" to end an injustice which is flagrantly unfair and foolishly wasteful.

This argument is sponsored by:

DOROTHY GLASS, President,

San Francisco County Club of Adult Blind.

ROBERT W. CAMPBELL, President,

California Council for the Blind.

On August 30, 1954, the Board of Supervisors authorized the foregoing argument for inclusion in the election pamphlet for November 2, 1954, by the following vote:

Ayes: Supervisors Arnold, Carberry, Christopher, Dobbs, Ferdon, Halley, McCarty, McMahan, Mead.

Absent: Supervisors Lewis, McAteer.

JOHN R. McGRATH, Clerk.

### PROPOSITION F

**Amends Charter Section 10; fixes salaries and bonds of members of Board of Supervisors; provides for meetings.**

#### CHARTER AMENDMENT PROPOSITION "F"

Describing and setting forth a proposal to the qualified electors of the City and County of San Francisco to amend the charter of said city and county by amending Section 10 thereof, relating to Number, Compensation and Meetings of Supervisors.

The Board of Supervisors of the City and County of San Francisco hereby submits to the qualified electors of said city and county at an election to be held therein on November 2, 1954, a proposal to amend the charter of said city and county by amending Section 10 thereof so that the same shall read as follows:

Note: Additions or substitutions are indicated by bold-face type; deletions are indicated by ((double parentheses)).

### NUMBER, COMPENSATION AND MEETINGS OF SUPERVISORS—PRESIDENT

Section 10. The Board of Supervisors shall consist of eleven members elected at large ((, provided that for the period January 8, 1932, to January 8, 1934, the board shall consist of fifteen members)).

Each member of the board shall be paid a salary of **five thousand dollars (\$5,000)** ((twenty-four hundred dollars (\$2,400) )) per year, and each shall ((execute)) furnish an official bond ((to the city and county)) in the sum of **ten thousand dollars (\$10,000)** ((five thousand dollars (\$5,000) )).

At ((twelve o'clock noon)) **two o'clock p.m.**, on the ((8th day)) **first Monday** of January ((next following their election,)) **in even numbered years** the ((newly elected and continuing members of the)) board of supervisors shall meet at the legislative chamber in the City Hall, and thereafter regular meetings shall be held **at the same place**, ((as)) **at the hour fixed by resolution**, ((. The supervisors constituting the new board shall, on January 8, 1932, and every second year thereafter, elect one of their number as president of the board for a two-year term. The president shall preside at all meetings, shall appoint all standing and special committees of the board, and shall have such other powers and duties as the supervisors may provide.

((The meetings of the board shall be held in the City Hall,)) provided that, in case of emergency, the board ((, by resolution)) may designate some other appropriate place as its temporary meeting place. ((The board shall cause a calendar of the business scheduled for each meeting to be published and shall keep and publish a journal of its proceedings.))

Notice of any special meeting shall be published or posted ((at least twenty-four hours in advance of such special meeting)).

Each board of supervisors shall, at its inaugural meeting, elect one of its number to serve as president of the board for a two-year term.

The president shall preside at all meetings, shall appoint all standing and special committees of the board and shall have such other powers and duties as the supervisors may provide.

Ordered submitted: Board of Supervisors, San Francisco, Aug. 2, 1954.

Ayes: Supervisors Arnold, Carberry, Christopher, Dobbs, Ferdon, Halley, Lewis, McAteer, McCarty, McMahan, Mead.

I hereby certify that the foregoing charter amendment was ordered submitted by the Board of Supervisors of the City and County of San Francisco.

JOHN R. McGRATH, Clerk.

### ARGUMENT FOR PROPOSITION "F"

#### Vote Yes on Proposition "F"

Proposition "F" makes the first change in salaries of the Board of Supervisors in 40 years. Here are some of the reasons why you should vote YES on Proposition "F":

## Supervisors Are Still Paid a 1911 Salary

In 1911 . . . .

The salary of a Supervisor was set at \$200 a month. (There was no income tax in 1911.)

In 1954 . . . .

The cost of living is up almost three times over 1911. Most jobs pay four times more than they did 40 years ago. Most salaries have doubled in the last 10 years. Today a Supervisor still gets \$200 but has actually taken a big pay cut—considering the 46 cent dollar and heavy income taxes.

### A Supervisor's Job Is Bigger Today Than It Was in 1911

San Francisco's population in 1911 was 416,000. Today it is 798,000. A greater population has broadened the scope of government, created more responsibility for Supervisors.

San Francisco's annual budget in 1911 was about fifty million dollars. Today it is over one hundred and eighty million dollars. Running a one hundred and eighty million dollar a year business is a big job.

The progress of 40 years has brought many changes in government. A Supervisor now works on many projects that did not exist in 1911.

In 1911 San Francisco had 18 Supervisors. Today we have 11. Today we have fewer Supervisors sharing a vastly increased work load.

Elsewhere in the country the taxpayer pays the salaries of both City Councilmen and County Supervisors. Here in San Francisco a Supervisor does both jobs, draws one salary.

Proposition "F" and this argument in support thereof are recommended and sponsored by the Charter Revision Committee.

LLOYD E. GRAYBIEL, Chairman.

A "Yes" vote on Proposition "F" is endorsed by: Down Town Association; Hospital and Institutional Workers Union, Local 250, A. F. of L.; San Francisco Chamber of Commerce; San Francisco Real Estate Board; San Francisco Junior Chamber of Commerce; Building Owners and Managers Association; California Northern Hotel Association; Retail Merchants Association; Apartment House Association of San Francisco, Inc.; Retail Dry Goods Association; San Francisco Labor Council.

On August 30, 1954, the Board of Supervisors authorized the foregoing argument for inclusion in the election pamphlet for November 2, 1954, by the following vote:

Ayes: Supervisors Arnold, Carberry, Christopher, Dobbs, Ferdon, Halley, McCarty, McMahan, Mead.

Absent: Supervisors Lewis, McAteer.

JOHN R. McGRATH, Clerk.

## CONTROLLER'S STATEMENT PURSUANT TO CHARTER SECTION 183

### PROPOSITION "F"

Should proposition "F" be enacted it is estimated that the cost of government of the City and County of San Francisco would be increased by \$28,600 each year. Based on the current assessment roll said amount of \$28,600 will be equivalent to an increase of two tenths of one cent in the tax rate.

HARRY D. ROSS, Controller,  
City and County of San Francisco.

## PROPOSITION G

**Amends Charter Section 59; requires confirmation by Board of Supervisors of appointment of Chief Administrative Officer; deletes prior residence requirement and provides removal, suspension and other procedure.**

### CHARTER AMENDMENT PROPOSITION "G"

Describing and setting forth a proposal to the qualified electors of the City and County of San Francisco to amend the charter of said city and county by amending Section 59 thereof, relating to the appointment, removal and qualifications of the Chief Administrative Officer.

The Board of Supervisors of the City and County of San Francisco hereby submits to the qualified electors of said city and county at an election to be held therein on November 2, 1954, a proposal to amend the charter of said city and county by amending Section 59 thereof, so that the same shall read as follows:

Note: Additions or substitutions are indicated by bold-face type; deletions are indicated by ((double parentheses)).

#### CHIEF ADMINISTRATIVE OFFICER

Section 59. The mayor shall appoint as chief administrative officer a qualified person, subject to confirmation by a majority of the board of supervisors, ((who shall have been a resident of the State of California for at least five years immediately preceding his appointment.)) who must be a citizen of the United States, provided however, that notwithstanding the provisions of section 7 of the charter, need not at the time of his appointment be a resident of the City and County or the State of California, or an elector thereof, and provided further that he shall be allowed a reasonable time after the date of his appointment, not exceeding one year, to become a resident of the City and County as defined in section 7 of the charter. ((The requisite qualifications of such appointee)) Such appointment shall be made solely on the basis of qualification by training, administrative and executive ability, and experience for the position to be filled. ((The first such appointment shall be made immediately after twelve o'clock noon on the 8th day of January, 1932. He shall be paid an annual salary of twelve thousand dollars (\$12,000).)) Such confirmation by the board of supervisors shall be not less than thirty days nor more than sixty days after the appointment shall have been submitted by the mayor.

He shall be subject to suspension and removal in the same manner as ((elective officers)) an elected officer.

He shall also be subject to suspension and removal as follows: He may be removed by the mayor and a majority of the board of supervisors, or by a vote of not less than two-thirds of the board of supervisors ((, on the basis of written charges, and, )) without concurrence of the mayor, upon resolution declaring his removal submitted by a supervisor or by the mayor and after notice of the submission of such resolution has been given him by the clerk of the board of supervisors at least five days before action thereon. If he so requests, he shall be furnished in writing a statement of the grounds of his removal, and if he so requests the board of supervisors shall conduct ((only after)) a public hearing on such written charges ((before

the board of supervisors)) not less than five days nor more than fifteen days after such request has been made ((the filing thereof,)) and prior to the date on which the board of supervisors shall vote on the question of his removal. ((, but on the filing of written charges, and pending and during such hearing the supervisors, by majority vote, may suspend him from office.)) After the submission to the board of supervisors by a supervisor or the mayor of the resolution declaring his removal, and pending final action on his removal, the chief administrative officer may be suspended from office by a majority vote of the supervisors. ((The written charges and any reply thereto by the chief administrative officer shall be entered at length in the journal of the board of supervisors.))

The action of the board of supervisors in removing the chief administrative officer as herein provided shall be final.

In the event of the vacancy in the office of chief administrative officer the executive assistant to the chief administrative officer shall be the acting chief administrative officer pending appointment and confirmation of a successor.

Ordered submitted: Board of Supervisors, San Francisco, August 30, 1954.

Ayes: Supervisors Arnold, Carberry, Christopher, Dobbs, Ferdon, Halley, Mead.

Noes: Supervisors McCarty, McMahan.

Absent: Supervisors Lewis, McAteer.

I hereby certify that the foregoing charter amendment was ordered submitted by the Board of Supervisors of the City and County of San Francisco.

JOHN R. McGRATH, Clerk.

## PROPOSITION H

**Adds Charter Sections 165.2.1, 165.2.2, 165.2.3 and 172.0.1, relating to disability benefits and retirement and death allowances respecting ambulance drivers and stewards in Emergency Hospital Service incapacitated by service connected bodily injury or illness.**

### CHARTER AMENDMENT PROPOSITION "H"

Describing and setting forth a proposal to the qualified electors of the City and County of San Francisco to amend the charter of said city and county by adding thereto, Sections 165.2.1, 165.2.2, 165.2.3 and 172.0.1 relating to disability benefits and retirement and death allowances respecting Stewards and Ambulance Drivers in the Emergency Hospital Service.

The Board of Supervisors of the City and County of San Francisco hereby submits to the qualified electors of said city and county at an election to be held therein on November 2, 1954, a proposal to amend the charter of said city and county by adding thereto Sections 165.2.1, 165.2.2, 165.2.3, and 172.0.1, reading as follows:

Note: Additions indicated by bold-face type.

Section 165.2.1. Any member under Section 165.2, whose duties are the duties now performed under the titles of ambulance driver or steward in the emergency hospital service, who becomes incapacitated for the per-

formance of his duties by reason of bodily injury received in, or illness caused by performance of such duties, shall be retired, and if he is not qualified for service retirement, shall receive a retirement allowance, in lieu of any allowance payable on account of such incapacity, under any other section of the Charter or Ordinance, equal to seventy-five per cent of the average final compensation of said member, as defined in Section 165.2. Said allowance shall be paid to him until the date upon which said member would have qualified for service retirement had he lived and rendered service without interruption in the position held by him at retirement, and after said date the allowance payable shall be equal to the retirement allowance said member would have received if retired for service on said date, based on the average monthly compensation he would have received during the five years immediately prior to said date, had he lived and rendered service as assumed, but such allowance shall not be less than one-half of such average monthly compensation. If at the time of retirement under this section he is qualified as to age and service for retirement under Section 165.2, he shall receive an allowance equal to the retirement allowance which he would receive if retired under Section 165.2, but not less than fifty per cent of said average final compensation. The question of retiring a member under this section may be brought before the retirement board on said board's own motion, by recommendation of the head of his department, or by said member or his guardian. If his disability shall cease, his retirement allowance shall cease, and he shall be restored to the service in the position or classification he occupied at the time of his retirement. "Qualified for service retirement," "qualification for service retirement," and "Qualified as to age and service for retirement," as used in this section shall mean completion of ten years of credited service and attainment of the age of sixty years, or attainment of the age of sixty-five years regardless of credited service. Contributions being required of the city and county currently, as percentages of salaries of persons who are members under Section 165.2, shall be increased by an increase in said percentages determined by the actuary as necessary to pay the benefits under this section.

Section 165.2.2. If any member under Section 165.2, whose duties are the duties now performed under the titles of ambulance driver or steward in the emergency hospital service, shall die before or after retirement by reason of an injury received in, or illness caused by the performance of such duties, a death allowance, in lieu of any allowance or other benefit payable on account of such death before retirement, under any other section of the charter or ordinance, shall be paid, beginning on the date next following the date of death, to his surviving wife, throughout her life or until her remarriage. If the member, at the time of death, was qualified for service retirement, but had not retired, the allowance payable shall be equal to the retirement allowance which the member would have received if he had been retired for service on the day of death, but such allowance shall not be less than one-half of his average final compensation, as defined in Section 165.2. If death occurs prior to qualification for service retirement the allowance payable shall be equal to the compensation of said member at the time of his death, until the date upon which said member would have qualified for service retirement, had he lived and rendered service without interruption in the position held by him at death, and after said date the allowance payable shall be equal to the retirement allowance said member would have received if retired for service on said date, based on the average monthly compensation he would have received during the five years immediately prior to said date, had he lived and

rendered service as assumed, but such allowance shall not be less than one-half of such average monthly compensation. If he had retired prior to death for service or for disability resulting from injury received in, or illness caused by the performance of duty, the allowance payable shall be equal to the retirement allowance of the member, except that if he was a member under Section 165.2 and retirement was for such disability, and if death occurred prior to qualification for service retirement, the allowance payable shall be reduced upon the date at which said member would have qualified for service retirement, in the same manner as it would have been reduced had the member not died. If there be no surviving wife entitled to an allowance hereunder, or if she die or remarry before every child of such deceased member attains the age of eighteen years, then the allowance which the surviving wife would have received had she lived and not remarried shall be paid to his child or children under said age, collectively, to continue until every such child dies or attains said age, provided that no child shall receive any allowance after marrying or attaining the age of eighteen years. Should said member leave no surviving wife and no children under the age of eighteen years, but leave a parent or parents dependent upon him for support, the parents so dependent shall collectively receive a monthly allowance equal to that which a surviving widow otherwise would have received, during such dependency. No allowance, however, shall be paid under this section to a surviving wife following the death of a member unless she was married to the member prior to the date of the injury or onset of the illness which results in death. "Qualified for service retirement," and "qualification for service retirement" as used in this section shall mean completion of ten years of credited service and attainment of the age of sixty years, or attainment of the age of sixty-five years regardless of credited service. Contributions being required of the city and county currently, as percentages of salaries of persons who are members under Section 165.2, shall be increased by an increase in said percentages determined by the actuary as necessary to pay the benefits under this section.

Section 165.2.3. That portion of any allowance payable because of the death or retirement of any member under the provisions of Sections 165.2.1 or 165.2.2, which is provided by contributions of the city and county, shall be reduced in the manner fixed by the board of supervisors, by the amount of any benefits other than medical benefits, payable to or on account of such person, under the Workmen's Compensation Insurance and Safety Law of the State of California and because of the injury or illness resulting in said death or retirement. Such portion which is paid because of death or retirement which resulted from injury received in or illness caused by performance of duty, shall be considered as in lieu of all benefits, other than medical benefits, payable to or on account of such person under said law of the State of California and shall be in satisfaction and discharge of the obligation of the city and county to pay such benefits.

Section 172.0.1. Whenever any member under Section 165.2, whose duties are the duties now performed under the title of ambulance driver or steward in the emergency hospital service, is incapacitated for the performance of his duties by reason of any bodily injury received in or illness caused by the performance of his duty, as determined by the retirement board, he shall become entitled, regardless of his period of service with the city and county, to disability benefits equal to and in lieu of his salary, while so disabled, for a period or periods not exceeding twelve months in the aggregate, with respect to any one injury or illness. Said disability

benefit shall be reduced in the manner fixed by the board of supervisors by the amount of any benefits other than medical benefits payable to such person under the Labor Code concurrently with said disability benefit, and because of the injury or illness resulting in said disability. Such disability benefits as are paid in the absence of payments of any benefits other than medical benefits under the workmen's compensation laws included in said Labor Code, shall be considered as in lieu of such benefits, payable to such person under the said Code concurrently with said disability benefits, and shall be in satisfaction and discharge of the obligations of the city and county to pay such benefits under the Labor Code. Medical treatment which may become necessary to relieve or cure said member from the effects of the injury or illness shall be furnished by the city and county, in the same manner that such treatment is furnished under said Labor Code, but without first requiring continuing awards of such treatment by the Industrial Accident Commission of the State of California, relating to impairments of permanent or of extended and uncertain duration. The provisions of this paragraph shall be administered exclusively by the retirement board, and the city and county shall pay to the retirement system during each fiscal year, an amount equal to the total disability benefits paid by said system during that year. Such member shall receive credit as service, under the retirement system, for time during which he is incapacitated for performance of duty and receives said disability benefit. Contributions for the retirement system shall be deducted from said benefits in the same manner as they would be deducted from salary paid to him, and the city and county shall contribute, in addition to its other contributions provided herein, to the retirement system on the basis of said benefits in the same manner as it would contribute on salary paid to said member.

Ordered submitted: Board of Supervisors, San Francisco, Sept. 7, 1954.

Ayes: Supervisors Arnold, Carberry, Christopher, McAteer, McCarty, Mead.

Noes: Supervisors Dobbs, Ferdon, Halley, McMahon.

Absent: Supervisor Lewis.

I hereby certify that the foregoing charter amendment was ordered submitted by the Board of Supervisors of the City and County of San Francisco.

JOHN R. McGRATH, Clerk.

### ARGUMENT FOR PROPOSITION "H"

#### Amending City Charter to Provide Disability and Death Benefits for Emergency Hospital Service Ambulance Drivers and Stewards Injured or Killed In the Line of Duty.

The Ambulance Stewards and Drivers of the San Francisco Emergency Hospital Service constitute an emergency group that is left virtually unprotected in case of disabling injury or death sustained in line of their hazardous duties.

These men are frequently exposed to varied hazards. Although they respond with the police to shootings, stabbings and other critical emergencies such as fires and explosions they do not now have the protection that is accorded other emergency groups.

#### Vote "Yes" on "H"

Abnormal traffic hazards created under pressure of emergency are a constant potential. More than 30,000 calls, under all conditions, are made by the 62 uniformed men of this Service each year.

Proposition "H" would set up a program providing disability and death benefits for these employees comparable to other emergency groups at an infinitesimal cost to the community.

### Vote "Yes" on "H"

Our emergency service is admittedly one of the finest in the country and its members should be afforded adequate protection from the inherent risks incurred in performing their errands of mercy.

### Vote "Yes" on "H"

This argument is sponsored by the Committee for Proposition "H."

JOSEPH LANTHIER, Chairman.

A "Yes" vote on Proposition "H" is endorsed by: San Francisco Federation of Municipal Employees, Inc.; San Francisco Building and Construction Trades Council; San Francisco Medical Society; George R. Reilly; James J. Reilly; James L. Quigley; Michael Riordan; Wilhelm Waldeyer, M.D.; Mrs. George W. Cuniffe; Mrs. Edward P. Walsh; Mrs. John J. Harrington; Mrs. Thomas J. O'Toole; Alice E. Hermann; Mrs. John J. Murray; Harold Schulz; Cornelius Lynch; Edward J. Bud Duggan; Malachy Ruane; Jack McBride; Robert Hassing; San Francisco Labor Council.

On September 13, 1954, the Board of Supervisors authorized the foregoing argument for inclusion in the election pamphlet for November 2, 1954, by the following vote:

Ayes: Supervisors Arnold, Carberry, Christopher, Dobbs, Ferdon, Halley, Lewis, McAteer, McCarty, McMahan.

Absent: Supervisor Mead.

JOHN R. McGRATH, Clerk.

## ARGUMENT AGAINST PROPOSITION "H"

### Vote "No" On Proposition "H." Defeat This Special Pension Measure

Voters are asked to disapprove this unsound measure that gives police and firemen's pension benefits to a group of ambulance drivers and stewards. Policemen and firemen have been granted liberal disability and death benefits because of the extreme danger their duties involve. Experience shows that special disability and death benefits for these health department employees are not merited.

Proposition "H" sets a bad precedent. If this measure is approved many other groups of city employees would demand the same benefits. The disability and death benefits now provided for these groups are considered adequate.

The city pension system now requires a budget of \$16,364,681 in city funds, of which \$10,320,048 comes from the taxpayers, and this amount would be greatly increased if these special benefits were given to all city employees.

**Defeat This Special Legislation      Preserve a Sound City Pension System**

### Vote "No" On Proposition "H"

This argument is sponsored by the San Francisco Municipal Conference, composed of representatives of the following organizations:

Building Owners & Managers Assn.  
California Northern Hotel Assn.  
Down Town Association

San Francisco Chamber of Commerce  
S. F. Junior Chamber of Commerce  
San Francisco Real Estate Board

Apartment House Assn. of San Francisco

DANTE P. LEMBI, Chairman.

CONTROLLER'S STATEMENT PURSUANT TO CHARTER  
SECTION 183

**PROPOSITION "H"**

The total present value of the portion of the proposed benefit accruing to these 62 employees, chargeable to the City and County of San Francisco based on report of the San Francisco Employees' Retirement System is estimated at \$535,244, to be funded by annual contributions by the City and County of San Francisco of \$50,193. Based upon the current assessment roll, \$50,193 annually will be equivalent to four tenths of one cent in the tax rate.

HARRY D. ROSS, Controller.

**PROPOSITION I**

**Adds Charter Sections 165.2.4, 165.2.5, 165.2.6 and 172.0.2, relating to disability benefits and retirement and death allowances respecting certain employees of Sheriff's Office incapacitated by service connected bodily injury or illness.**

**CHARTER AMENDMENT**

**PROPOSITION "I"**

Describing and setting forth a proposal to the qualified electors of the City and County of San Francisco to amend the charter of said city and county by adding thereto, Sections 165.2.4, 165.2.5, 165.2.6, and 172.0.2 relating to disability benefits and retirement and death allowances respecting certain employees of the Sheriff's Office.

The Board of Supervisors of the City and County of San Francisco hereby submits to the qualified electors of said city and county at an election to be held therein on November 2, 1954, a proposal to amend the charter of said city and county by adding thereto Sections 165.2.4, 165.2.5, 165.2.6, and 172.0.2, reading as follows:

Additions indicated by bold-face type.

**Section 165.2.4. Any member under Section 165.2, or 165, who is an officer or employee of the Sheriff's Office, and whose duties are the duties now performed under the titles of Bailiff, Detention Hospital Bailiff, Jail Matron, Head Jail Matron, Jailer, Superintendent of Jail, Chauffeur, Keeper, Head Keeper, Chief Clerk, Writ Server, or Captain of Watch, who becomes incapacitated for the performance of his duties by reason of bodily injury received in, or illness caused by performance of such duties, whether or not performed within the limits of the city and county, shall be retired, and if he is not qualified for service retirement, shall receive a retirement allowance, in lieu of any allowance payable on account of such incapacity, under any other section of the charter or ordinance, equal to seventy-five per cent of the average final compensation of said member, as defined in Section 165.2. Said allowance shall be paid to him until the date upon which said member would have qualified for service retirement had he lived and rendered service without interruption in the position held by him at retirement, and after said date the allowance payable shall be equal to the retirement allowance said member would have received if retired for service on said date, had he lived and rendered service as assumed, but such allowance shall not be less than one-half of the average monthly compensation he would have received during the five years immediately prior**

to said date. If on the date of retirement under this section he is qualified as to age and service for retirement, he shall receive an allowance equal to the retirement allowance which he would receive if retired for service on said date, but not less than fifty percent of his average final compensation, as defined under Section 165.2. The question of retiring a member under this section may be brought before the retirement board on said board's own motion, by recommendation of the head of his department, or by said member or his guardian. If his disability shall cease, his retirement allowance shall cease, and he shall be restored to the service in the position or classification he occupied at the time of his retirement. "Qualified for service retirement," "qualification for service retirement," and "qualified as to age and service for retirement," as used in this section shall mean completion of ten years of credited service and attainment of the age of sixty years, or attainment of the age of sixty-five years regardless of credited service. Contributions being required of the city and county currently, as percentages of salaries of persons who are members under Section 165.2, shall be increased by an increase in said percentages determined by the actuary as necessary to pay the benefits under this section.

Section 165.2.5. If any member under Section 165.2, or 165, who is an officer or employee of the Sheriff's Office, and whose duties are the duties now performed under the titles of Bailiff, Detention Hospital Bailiff, Jail Matron, Head Jail Matron, Jailer, Superintendent of Jail, Chauffeur, Keeper, Head Keeper, Chief Clerk, Writ Server, or Captain of Watch, shall die before or after retirement by reason of an injury received in, or illness caused by the performance of such duties, whether or not performed within the limits of the city and county, a death allowance, in lieu of any allowance or other benefit payable on account of such death before retirement, under any other section of the charter or ordinance, shall be paid beginning on the date next following the date of death, to his surviving wife, throughout her life or until her remarriage. If a member, at the time of death, was qualified for service retirement, but had not retired the allowance payable shall be equal to the retirement allowance which the member would have received if he had been retired for service on the day of death, but such allowance shall not be less than one-half of his average final compensation, as defined in Section 165.2. If death occurs prior to qualification for service retirement the allowance payable shall be equal to the compensation of said member at the time of his death, until the date upon which said member would have qualified for service retirement, had he lived and rendered service without interruption in the position held by him at death, and after said date the allowance payable shall be equal to the retirement allowance said member would have received if retired for service on said date, had he lived and rendered service as assumed, but such allowance shall not be less than one-half of the average monthly compensation he would have received during the five years immediately prior to said date. If he had retired prior to death for service or for disability resulting from injury received in, or illness caused by the performance of duty, the allowance payable shall be equal to the retirement allowance of the member, except that if retirement was for such disability, and if death occurred prior to qualification for service retirement, the allowance payable shall be reduced upon the date at which said member would have qualified for service retirement, in the same manner as it would have been reduced had the member not died. If there be no surviving wife entitled to an allowance hereunder, or if she die or remarry before every child of such deceased member attains the age of eighteen years, then the allowance which the surviving wife would have received had she lived and not

remarried shall be paid to his child or children under said age, collectively, to continue until every such child dies or attains said age, provided that no child shall receive any allowance after marrying or attaining the age of eighteen years. Should said member leave no surviving wife and no children under the age of eighteen years, but leave a parent or parents dependent upon him for support, the parents so dependent shall collectively receive a monthly allowance equal to that which a surviving widow otherwise would have received, during such dependency. No allowance, however, shall be paid under this section to a surviving wife following the death of a member unless she was married to the member prior to the date of the injury or onset of the illness which results in death. "Qualified for service retirement," and "qualification for service retirement" as used in this section shall mean completion of ten years of credited service and attainment of the age of sixty years, or attainment of the age of sixty-five years regardless of credited service. Contributions being required of the city and county currently, as percentages of salaries of persons who are members under Section 165.2, shall be increased by an increase in said percentages determined by the actuary as necessary to pay the benefits under this section.

Section 165.2.6. That portion of any allowance payable because of the death or retirement of any member under the provisions of Sections 165.2.4 or 165.2.5, which is provided by contribution of the city and county, shall be reduced in the manner fixed by the board of supervisors, by the amount of any benefits other than medical benefits, payable to or on account of such person, under the Workmen's Compensation Insurance and Safety Law of the State of California and because of the injury or illness resulting in said death or retirement. Such portion which is paid because of death or retirement which resulted from injury received in or illness caused by performance of duty, shall be considered as in lieu of all benefits, other than medical benefits, payable to or on account of such person under said law of the State of California and shall be in satisfaction and discharge of the obligation of the city and county to pay such benefits.

Section 172.0.2. Whenever any member under Section 165.2, or 165, who is an officer or employee of the Sheriff's Office, and whose duties are the duties now performed under the titles of Bailiff, Detention Hospital Bailiff, Jail Matron, Head Jail Matron, Jailer, Superintendent of Jail, Chauffeur, Keeper, Head Keeper, Chief Clerk, Writ Server, or Captain of Watch, is incapacitated for the performance of his duties by reason of any bodily injury received in or illness caused by the performance of his duty, whether or not performed within the limits of the city and county, as determined by the retirement board, he shall become entitled, regardless of his period of service with the city and county, to disability benefits equal to and in lieu of his salary, while so disabled, for a period or periods not exceeding twelve months in the aggregate, with respect to any one injury or illness. Said disability benefit shall be reduced in the manner fixed by the board of supervisors by the amount of any benefits other than medical benefits payable to such person under the Labor Code concurrently with said disability benefit, and because of the injury or illness resulting in said disability. Such disability benefits as are paid in the absence of payments of any benefits other than medical benefits under the Workmen's Compensation Laws included in said Labor Code, shall be considered as in lieu of such benefits, payable to such person under the said Code concurrently with said disability benefits, and shall be in satisfaction and discharge of the obligations of the city and county to pay such benefits under the Labor

Code. Medical treatment which may become necessary to relieve or cure said member from the effects of the injury or illness shall be furnished by the city and county, in the same manner that such treatment is furnished under said Labor Code, but without first requiring continuing awards of such treatment by the Industrial Accident Commission of the State of California, relating to impairments of permanent or of extended and uncertain duration. The provisions of this paragraph shall be administered exclusively by the retirement board, and the city and county shall pay to the retirement system during each fiscal year, an amount equal to the total disability benefits paid by said system during that year. Such member shall receive credit as service, under the retirement system, for time during which he is incapacitated for performance of duty and receives said disability benefit. Contributions for the retirement system shall be deducted from said benefits in the same manner as they would be deducted from salary paid to him, and the city and county shall contribute, in addition to its other contributions provided herein, to the retirement system on the basis of said benefits in the same manner as it would contribute on salary paid to said member.

Ordered submitted: Board of Supervisors, San Francisco, Sept. 7, 1954.

Ayes: Supervisors Arnold, Carberry, Christopher, McAteer, McCarty, Mead.

Noes: Supervisors Dobbs, Ferdon, Halley, McMahon.

Absent: Supervisor Lewis.

I hereby certify that the foregoing charter amendment was ordered submitted by the Board of Supervisors of the City and County of San Francisco.

JOHN R. McGRATH, Clerk.

### ARGUMENT FOR PROPOSITION "I"

#### Vote "Yes" on Proposition "I"

The protection provided in this proposed amendment will apply if and when a San Francisco Deputy Sheriff is killed or injured in the line of duty. At the present time there is no pension provided for the family of a Deputy Sheriff who is killed or injured. The protection requested is similar to that now received by Deputies in Alameda, Los Angeles and many other counties throughout the state.

This is the first time in the history of your city that your Sheriff's Department has asked for any special consideration.

Remember—This protection applies only if and when a Deputy is killed or injured in the line of duty.

#### Vote "Yes" on Proposition "I"

This argument is sponsored by the Deputy Sheriffs Association of San Francisco.

HUGH E. MAGUIRE, President.

On September 13, 1954, the Board of Supervisors authorized the foregoing argument for inclusion in the election pamphlet for November 2, 1954, by the following vote:

Ayes: Supervisors Arnold, Carberry, Christopher, Dobbs, Ferdon, Halley, Lewis, McAteer, McCarty, McMahon.

Absent: Supervisor Mead.

JOHN R. McGRATH, Clerk.

## ARGUMENT AGAINST PROPOSITION "I"

### Vote "No" On Proposition "I." Defeat This Special Pension Measure

Proposition "I," like Proposition "H," would give police and fire disability and death benefits to a selected group of employees in the Sheriff's Office. This group includes a chief clerk, bailiffs, writ servers, etc. The number affected is 132. Voters have granted liberal disability and death benefits to policemen and firemen because their duties expose them to great danger. These Sheriff's employees are seeking the same special benefits.

In the past ten years there have been no recorded cases of disability or death connected with duty among these employees.

Voters are asked to vote "No" on this measure because it would, like Proposition "H," set a precedent for other city employees. Other employees would demand the same pension coverage as this small group is now seeking with this amendment. The cost of such coverage for all employees would be tremendous. Present death and disability benefits for these employees are considered adequate.

### Protect the City's Pension System Defeat This Unsound Measure

#### Vote "No" On Proposition "I"

This argument is sponsored by the San Francisco Municipal Conference, composed of representatives of the following organizations:

Building Owners & Managers Assn.

California Northern Hotel Assn.

Down Town Association

San Francisco Chamber of Commerce

S. F. Junior Chamber of Commerce

San Francisco Real Estate Board

Apartment House Assn. of San Francisco

DANTE P. LEMBI, Chairman.

### CONTROLLER'S STATEMENT PURSUANT TO CHARTER SECTION 183

#### PROPOSITION "I"

The total present value of the portion of the proposed benefit, accruing to these 132 employees, chargeable to the City and County of San Francisco based on report of the San Francisco Employees' Retirement System is estimated at \$969,129, to be financed by annual contributions by the City and County of San Francisco of \$90,761. Based upon the current assessment roll, \$90,761 annually will be equivalent to seven tenths of one cent in the tax rate.

HARRY D. ROSS, Controller.

#### PROPOSITION J

**Amends Charter Section 119.3; requires maintenance and operation of all cable car lines existing January 1, 1954; requires electors' approval of sale, lease, abandonment or curtailment of lines; repeals prior action of electorate.**

#### CHARTER AMENDMENT PROPOSITION "J"

(Proposed by petition of the electors)

Describing and setting forth a proposal to the qualified electors of the City and County of San Francisco, State of California, to amend the Charter of said City and County by amending Section 119.3 thereof relating to operation of cable cars to be voted upon at an election to be held therein on November 2, 1954.

Section 119.3 of the Charter of the City and County of San Francisco is hereby amended to read as follows:

Note: Additions or substitutions are indicated by **bold-face type**; deletions are indicated by ((double parentheses)).

### OPERATION OF CABLE CARS.

Section 119.3. In the conduct of the municipal railway ((the public utilities commission shall maintain and operate the present and existing cable car system now operated by the municipal railway)) a cable car system shall be maintained and operated by the City and County of San Francisco in the interest of the public safety and convenience ((and as a link with San Francisco's historic past)). Such system shall consist of all cable car lines in existence on January 1, 1954.

All officers, employees, boards, commissions, and departments of the City and County of San Francisco are hereby directed and empowered to perform all acts within their respective jurisdictions, but subject to the fiscal provisions of the charter, which shall be necessary to the restoration and establishment, and the continued maintenance and operation, of all cable car lines that were in existence on January 1, 1954.

Any ordinance or administrative measure involving the sale, lease, abandonment, or curtailment of any such cable car line, or part thereof, must be referred and submitted by the board of supervisors to a vote of the electors of the City and County of San Francisco at the election next ensuing, not less than sixty days after the adoption of such ordinance or other measure, and shall not go into effect until ratified by a majority of the electors voting thereon.

Any action by the electors to amend this section 119.3 at any election held prior to that in which this amendment is submitted to the electors is hereby superseded, revoked, and repealed. This section shall have precedence over section 121 of the charter of said city and county and any other section deemed in conflict herewith.

Ordered Submitted—Board of Supervisors, San Francisco, September 22, 1954.

Ayes: Supervisors Arnold, Carberry, Christopher, Dobbs, Ferdon, Halley, McAteer, McCarty, Mead.

Absent: Supervisors Lewis, McMahan.

I hereby certify that the foregoing charter amendment was ordered submitted by the Board of Supervisors of the City and County of San Francisco.

JOHN R. McGRATH, Clerk.

### ARGUMENT FOR PROPOSITION "J"

A "yes" vote on Initiative Proposition "J" will retain San Francisco's world-famous cable car system and restore the service that existed on January 1, 1954.

#### The June Cable Car Proposition ("E") Is Unwise and Costly

If passed, "J" supersedes former Proposition "E" which barely passed in June and has not yet been ratified by the State Legislature.

Proposition "E" was sponsored by opponents of the cable cars as an alleged "economy measure," but in fact would: (1) Destroy the Washington-Jackson line, which is heavily traveled and making money (\$36,000 a month), and require the tearing up of \$200,000 worth of brand new tracks on that

line, at a cost of almost \$600,000. (2) Destroy the outer California line and the Hyde, Jones and O'Farrell lines, all of which serve large areas. When the California line was acquired, Utilities Manager Turner pointed out that it enjoyed the "best riding habit" and its condition was such "that it could be operated longest with the least subsidy and the least amount of reconstruction." (3) Turn the remaining lines into a seasonal tourist attraction which will lose its appeal, if it is not a genuine transportation service patronized by residents, and will then become a costly burden and doom the cable car system to a "slow death." In August, 1954, the City Engineer urged buses on Powell Street, ostensibly only during heavy traffic. (4) Deprive residents in the Pacific Heights and other districts of direct downtown transportation. The riders of the Washington-Jackson and Hyde Street cable car lines are the downtown shoppers, and downtown and Polk Street merchants will suffer. (5) Require costly change-over of equipment, which is unnecessary under "J." The cable cars are of two types and are not interchangeable. (6) Require an indefinite shutdown of the entire system during reconversion, and create traffic problems during track removal and street repaving.

Slogans, such as "modernization" and "consolidation," etc., are misleading and untrue and do not present the true cost of "E," which will require the tearing up of tracks, the repaving of streets, the purchase of buses, and many other expenses in addition to the 4-cent per year increase in the tax rate that Controller Ross, in June, stated will be necessary if "E" goes into effect. All this will result in San Franciscans spending more than four million dollars needlessly and ending up with an amputated and untried cable car system, one-half its original size on January 1, 1954.

#### **"J" Entails No Additional Capital Expenditures and No Cost Except for Ordinary Repair and Maintenance**

The charge that it will cost millions has never been substantiated. No physical equipment need be restored and no conditioning and no new cable cars, tracks, or turntables are needed. The Controller's statement on this question is meaningless and ambiguous and based on P.U.C. "estimates."

The charges that cable cars lose money and cost more than buses are based upon misleading, unreliable and continuously changing financial comparisons prepared by an unfriendly management which always plays up and distorts cable car losses and plays down bus losses. The San Francisco Chronicle (March 15, 1954) observed that "The failure to get firm cost figures from the (utilities) management has been chronically the most baffling feature of the controversy." For example, they ignore the fact that buses wear out rapidly, that they are responsible for high damage claims, and that the city must pay a large amount in interest on its \$20,000-000 investment in buses. In fact, they assess a proportion of these interest and bond redemption charges against the cable cars.

A true financial picture would show that the cable cars produce the highest unit earnings (per mile) of our entire Municipal Railway system. Official reports and private engineering services affirm that the cable car system, in full operation under "J," may actually run at a profit if properly managed.

Moreover, the test of "paying their own way" ignores the need for public service and has not been applied to bus lines, many of which are operated under continuous loss. (All buses to outlying areas would be exterminated under such a test.)

Cable cars are clean, attractive, unique, open-air vehicles, last a lifetime, use no gasoline, oil, or tires, load and unload quickly, have a good safety record, are the only transportation designed for and suitable to our steep hills (the steepest in the United States), and do not add to the smog problem. Buses cannot serve the purpose, as residents in the areas will verify.

### **We Pledge Support for Any Change That Conditions Warrant**

"J" will not necessarily "freeze" all cable car routes forever. It authorizes changes by vote of the people. We stand for an intelligent survey by a qualified impartial committee, as opposed to Proposition "E," which was sponsored by an unfriendly Public Utilities Department committed in advance to oppose the entire cable car system and which arbitrarily chops out all important residential parts of the lines.

Do not be fooled by paper "festival committees" or biased transit or publicity "experts."

"J" will not benefit gas, oil, tire, bus or private garage interests, but it will preserve for San Francisco a valuable and efficient transportation system that is this city's trademark, and will restore good government and candor in the administration of our transportation system.

This argument is sponsored by the Cable Car Vigilantes, dedicated to saving San Francisco's Cable Cars.

MORRIS LOWENTHAL, Chairman.

### **ARGUMENT AGAINST PROPOSITION "J"**

#### **Vote "No" on Proposition "J." Do Not Restore Wasteful Cable Lines!**

Proposition "J" was placed on the ballot by an irreconcilable little group who refused to accept the mandate of the majority of the voters, who in June of this year approved a sound and economical plan for preservation of the cable car system. The cable system is now operating and will continue to operate in accord with this plan if Proposition "J" is defeated.

Don't be misled. This is an initiative measure that the Supervisors are required by law to submit to the voters, regardless of the merits of the proposition.

If this measure is approved the city and county Controller reports that the total annual cost will be \$544,453, which is equivalent to four and four-tenths (4.4c) in the tax rate on each \$100 of assessed value. The annual operating costs, the Controller states, will be increased \$430,000.

Proposition "J" must be defeated or the taxpayers will be forced to pay a larger Municipal Railway deficit that would ensue with restoration of the abandoned lines. The annual budget adopted by the Supervisors shows that the taxpayers must pay \$2,079,280 towards Municipal Railway operation this fiscal year, 1954-55. Cable car system losses averaged \$30,320 per month for the ten months from July 1, 1953, to April 30, 1954, before the uneconomical service was abandoned in accord with the voters' approved plan. In July, 1954, after curtailment of cable lines, this loss was reduced to \$365 for the entire month.

Proposition "J" freezes the whole uneconomic system in the charter. It has been forced on the voters by a stubborn little group of people who would not accept the voters' mandate in the June election. They want their way, regardless of cost or consequences. Do not let these people place this unnecessary tax increase on your home.

**Vote "No" on Proposition "J."**

**Retain a Sound, Economical Cable Car System!**

This argument is sponsored by the San Francisco Municipal Conference, composed of representatives of the following organizations:

Building Owners & Managers Assn.  
Down Town Association  
San Francisco Chamber of Commerce

Apartment House Assn. of S. F.  
S. F. Junior Chamber of Commerce  
San Francisco Real Estate Board  
DANTE P. LEMBI, Chairman.

**CONTROLLER'S STATEMENT PURSUANT TO CHARTER SECTION 183  
PROPOSITION "J"**

Should Proposition "J" be enacted, it is my judgment, after reviewing reports by the Public Utilities Commission's Bureau of Engineering, that the restoration of cable car lines as they existed on January 1, 1954, and subsequent proper conditioning as compared with proper conditioning of the cable car lines and substitute motor coach service as they are operated under existing law would require additional capital costs, including debt service, in the amount of \$114,453 annually for 15 years.

The operation of cable car lines as they existed on January 1, 1954, as compared with the operation of cable car lines and substitute motor coach service under existing law, would increase operating costs at current wage and price levels, by \$430,000 annually.

Based on the current assessment roll, the total annual cost of \$544,453 will be equivalent to four and four-tenths cents in the tax rate.

HARRY D. ROSS, Controller.



**VOTE EARLY**  
Polls Open From  
7 A.M. to 8 P.M.

The Voting Machine Will  
Record Votes **ONLY** Where  
The Pointers Are Left  
**DOWN.**



**DIRECTIONS  
FOR VOTING**



- 1st. **MOVE RED HANDLE LEVER** of VOTING MACHINE will go and **LEAVE IT THERE.**
- 2nd. **TO VOTE FOR CANDIDATES** of your choice pull names of the **CANDIDATES** for whom you wish **DOWN.**

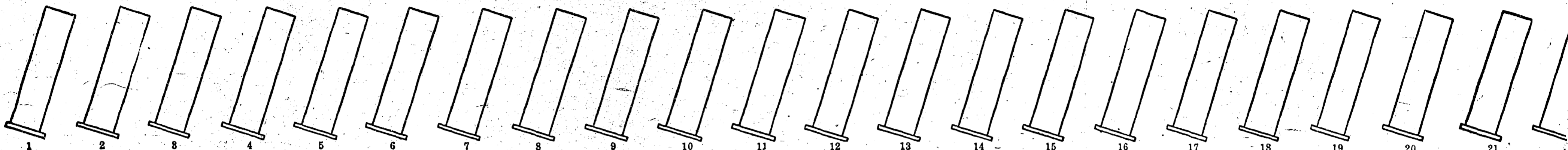

FOR PROPOSITION 1 VETERANS BOND ACT OF 1954. Act provides for a bond issue of \$175,000,000 to be used by Department of Veterans Affairs in assisting California war veterans to acquire farms and homes.	AGAINST PROPOSITION 2 SCHOOL BONDS. Constitutional Amendment. Authorizes sale of \$100,000,000 of State bonds to provide loans and grants to school districts for school buildings and sites, furniture and equipment.	YES PROPOSITION 3 ALCOHOLIC BEVERAGE CONTROL. Constitutional Amendment. Establishes Department of Alcoholic Beverage Control to administer liquor licensing laws in place of State Board of Equalization.	YES PROPOSITION 4 AID TO NEEDY AGED. Initiative Constitutional Amendment. Fixes \$100 (instead of present \$80) as maximum monthly payment to needy aged.	YES PROPOSITION 5 EXEMPTION OF VESSELS. Constitutional Amendment. Continues present tax exemption of California-registered freight and passenger ships of more than 50 tons burden.	YES PROPOSITION 6 PAY OF LEGISLATORS. Constitutional Amendment. Sets salaries of members of State Legislature at \$500 per month.	YES PROPOSITION 7 LAND TITLE LAW. Amendment of Initiative. Authorizes Legislature to amend or repeal Land Title Law (Torrens Act) adopted by initiative in 1914.	YES PROPOSITION 8 COMMERCIAL AND FISHING VESSELS. Constitutional Amendment. Continues tax exemption California-registered vessels, certain changes. Extends exemption to deep-sea fishing boats.
--	---	--	--	--	--	---	---

YES PROPOSITION A Exhibit Hall Bonds, 1954. To incur a bonded indebtedness in the sum of \$3,275,000 for the acquisition, construction and completion of an exhibit hall, including the relocation of utilities, all within the City and County of San Francisco.	YES PROPOSITION B Recreation Center Bonds, 1954. To incur a bonded indebtedness in the sum of \$5,000,000 for the acquisition, construction and completion of buildings, lands and other works and properties to be used for baseball, football, other sports, dramatic productions and other lawful uses as a recreation center.	YES PROPOSITION C San Francisco Hospital Bonds, 1954. To incur a bonded indebtedness in the sum of \$5,830,000 for the acquisition, construction and completion of buildings, lands, roadways, parking areas, utilities, and all other works, properties or structures necessary or convenient for the improvement of the San Francisco Hospital.	YES PROPOSITION D Laguna Honda Home and Hospital Bonds, 1954. To incur a bonded indebtedness in the sum of \$5,475,000 for the acquisition, construction and completion of buildings, lands, structures, and all other works or properties necessary or useful for additions and betterment to and rehabilitation of Laguna Honda Home and Hospital.	YES PROPOSITION E Adds Charter Section 145.02; declares policy to encourage hiring qualified blind persons in city service on equal opportunity with sighted persons; requires classification of positions, conduct of examinations and appointment accordingly.	YES PROPOSITION F Amends Charter Section 10; fixes salaries and bonds of members of Board of Supervisors; provides for meetings.	YES PROPOSITION G Amends Charter Section 59; requires confirmation by Board of Supervisors of appointment of Chief Administrative Officer; deletes prior residence requirement and provides removal, suspension and other procedure.	YES PROPOSITION H Adds Charter Sections 165.2, 165.2.2, 165.2.3 and 172.0.1, relating to disability benefits and retirement and death allowances respecting balance drivers and stewards; Emergency Hospital Service in pacitated by service connected bodily injury or illness.
--	--	--	---	---	---	---	---

1	2	3	4	5	6	7	8	9	10	11	12	13	14	15	16	17	18
<b>GOVERNOR</b> VOTE FOR ONE		<b>LIEUTENANT GOVERNOR</b> VOTE FOR ONE		<b>SECRETARY OF STATE</b> VOTE FOR ONE				<b>CONTROLLER</b> VOTE FOR ONE				<b>TREASURER</b> VOTE FOR ONE		<b>ATTORNEY GENERAL</b> VOTE FOR ONE		<b>MEMBER STATE BOARD OF EQUALIZATION</b> First District VOTE FOR ONE	

1-A GOODWIN J. Knight Republican Governor of California	2-A RICHARD PERRIN Graves Democratic Governmental Administrator	3-A HAROLD J. Powers Republican Lieutenant Governor	4-A EDWARD R. Roybal Democratic Member Los Angeles City Council	5-A FRANK M. Jordan Republican Secretary of State	6-A HORACE V. Alexander Independent Progressive Machinist	7-A DANIEL Raeburn Democratic Newspaper Publisher	8-A FRANK G. H. Stevens Prohibition Minister	9-A ROBERT C. Kirkwood Republican State Controller	10-A FRED H. Ross Prohibition	11-A GEORGE D. Collins, Jr. Democratic Assemblyman, 24th District, Calif. Legis.	12-A CHARLES G. Johnson Republican State Treasurer	13-A GEORGE E. Johnson Democratic Business Executive	14-A HERBERT S. Cohn Independent Progressive Attorney	15-A EDMUND G. (PAT) Brown Democratic Republican Attorney General of California	16-A EDWIN M. Cooper Prohibition	17-A GEORGE R. Reilly Democratic Incumbent	18-A STUART McClure Republican Newspaper
--	--	--	--	--	--	--	---	---	-------------------------------------	---	---	---	--	--	--	---	---

NE to the RIGHT as far as it

down the POINTERS over the  
to VOTE and LEAVE THEM

3rd. TO VOTE for a person whose name does not appear on the **BALLOT LABEL CARD**, raise numbered slide at top of machine corresponding to number of office on **OFFICE TITLE CARD**, and write name of candidate on paper under slide. (Do not pull down pointer over name of any candidate in office group in which you intend to write in name of a candidate.)

4th. TO VOTE FOR or AGAINST PROPOSITIONS or FOR or AGAINST CONFIRMA-

TION OF MEMBER OF BOARD OF EDUCATION, or FOR or AGAINST JUDICIAL OFFICERS, PULL DOWN pointers over words indicating your choice and LEAVE THEM DOWN.

5th. LEAVE THE POINTERS DOWN and move the RED HANDLE of the VOTING MACHINE to the LEFT as far as it will go and you have voted and your vote is registered.

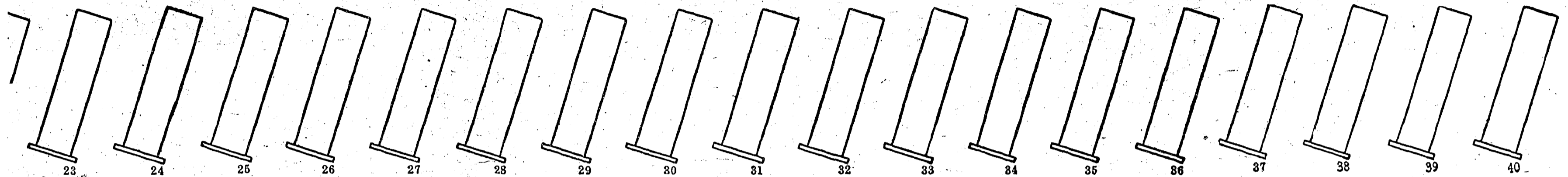

 <b>9</b> <b>CHURCH EXEMPTION.</b> Constitutional Amendment. Provides that tax exemption of church building during construction shall include building equipment and land on which building is located.	 <b>10</b> <b>TERMS OF OFFICE.</b> Constitutional Amendment. Fixes Assemblymen's terms at four years, State Senators' terms at six years. Limits future Governors to two successive terms.	 <b>11</b> <b>DISABLED VETERANS.</b> Constitutional Amendment. Authorizes tax exemption of home of veteran disabled through losing use of lower limbs when home has been acquired with Federal assistance.	 <b>12</b> <b>VOTING ELIGIBILITY.</b> Constitutional Amendment. Removes voting disqualification of convicted felon after he has completed punishment.	 <b>13</b> <b>VERNON CITY CHARTER.</b> Constitutional Amendment. Authorizes special city charter for City of Vernon in Los Angeles County. Describes permissive charter provisions.	 <b>14</b> <b>COLLEGE EXEMPTION.</b> Constitutional Amendment. Describes tax exemption of college buildings during construction as being inclusive of land on which building is located.	 <b>15</b> <b>WELFARE EXEMPTION.</b> Constitutional Amendment. Extends property tax exemption of nonprofit religious, hospital or charitable institution to include period when building is under construction.
---	--	--	---	---	--	---

 <b>I</b> Adds Charter Sections 165.2.4, 165.2.5, 165.2.6 and 172.0.2, relating to disability benefits and retirement and death allowances respecting certain employees of Sheriff's Office incapacitated by service connected bodily injury or illness.	 <b>J</b> Amends Charter Section 119.3; requires maintenance and operation of all cable car lines existing January 1, 1954; requires electors' approval of sale, lease, abandonment or curtailment of lines; repeals prior action of electorate.
--	--

**CITY AND COUNTY PROPOSITIONS**

LOWER ROW

**STATE PROPOSITIONS**

UPPER ROW

19 <b>UNITED STATES SENATOR</b> (Short Term, Ending January 3, 1957) VOTE FOR ONE	20	21	22 <b>REPRESENTATIVE IN CONGRESS</b> 4th Congressional District VOTE FOR ONE	23	24	25 <b>STATE SENATOR</b> 14th Senatorial District VOTE FOR ONE	26	27 <b>MEMBER OF ASSEMBLY</b> 22nd Assembly District VOTE FOR ONE	28	29 <b>ASSOCIATE JUSTICE SUPREME COURT</b>	30	31 <b>ASSOCIATE JUSTICE SUPREME COURT</b>	32	33 <b>ASSOCIATE DISTRICT OF APPEALS</b> First Appellate Division
--	----	----	---	----	----	--	----	---	----	--	----	--	----	--

19-A <b>THOMAS H. Kuchel</b> Republican United States Senator	20-A <b>SAMUEL WILLIAM Yorty</b> Democratic Member of United States Congress	21-A <b>ISOBEL M. Cerney</b> Independent Progressive Teacher and Writer	22-A <b>WILLIAM S. Mailliard</b> Republican United States Congressman	23-A <b>GEORGE R. Andersen</b> Independent Progressive Lawyer	24-A <b>PHILIP A. O'Rourke</b> Democratic Labor Executive	25-A <b>DONALD J. Bruce</b> Republican Retired	26-A <b>ROBERT I. McCarthy</b> Democratic Attorney at Law	27-A <b>BERNARD R. Brady</b> Democratic Incumbent	28-A <b>JOHN A. Busterud</b> Republican Attorney	29-A <b>YES</b>	30-A <b>NO</b>	31-A <b>YES</b>	32-A <b>NO</b>	33-A <b>YES</b>
--	---	--	--	--	--	---	--	--	---	--------------------	-------------------	--------------------	-------------------	--------------------

Shall  
**Douglas L. Edmonds**  
be elected to the office for the term prescribed by law?

Shall  
**John W. Shenk**  
be elected to the office for the term prescribed by law?

Shall  
**A. F. Br...**  
be elected to the office for the term prescribed by law?



or AGAINST JUDICIAL  
your choice and LEAVE

IF IN DOUBT AS TO OPERATING THE VOTING MACHINE, REQUEST INSTRU-  
CTIONS FROM THE INSPECTOR OR JUDGE OF THE ELECTION BOARD BEFORE  
ATTEMPTING TO VOTE.

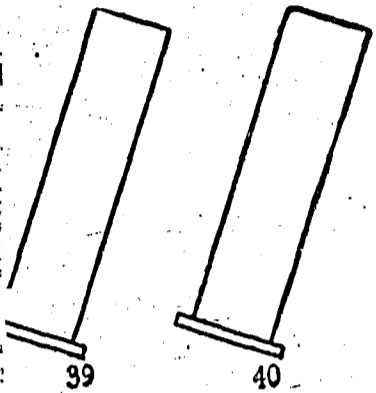

**SAMPLE BALLOT**  
**General Election**  
**NOVEMBER 2, 1954**

HANDLE of the VOTING  
as voted and your vote is





 YES PROPOSITION  NO



**15**  
**WELFARE EXEMPTION.** Constitutional Amendment. Extends property tax exemption of nonprofit religious, hospital or charitable institution to include period when building is under construction.

 YES PROPOSITION  NO



**16**  
**WATER RIGHTS OF GOVERNMENT AGENCIES.** Constitutional Amendment. Subjects real property acquisitions of local, State or Federal agencies to California water law.

 YES PROPOSITION  NO



**17**  
**HIGHWAY FUNDS.** Constitutional Amendment. Authorizes use of gasoline tax and other highway revenues to finance vehicle parking facilities as Legislature may prescribe.

 YES PROPOSITION  NO

**18**  
**NON CITIZENS' PROPERTY.** Constitutional Amendment. Confers on all resident foreigners same privileges of property ownership heretofore possessed by foreigners of white and African descent.

 YES PROPOSITION  NO

**19**  
**MUNICIPAL COURTS.** Constitutional Amendment. Under certain circumstances permits non-lawyer judge of justice court to succeed to judgeship of superseding municipal court.

 YES PROPOSITION  NO

**20**  
**COUNTY CHARTERS.** Constitutional Amendment. Extends freeholders' time for preparing county charter to six months. Alters requirements for nominating candidates for freeholder.

32  
**JUDGE OF THE DISTRICT COURT**

33  
**ASSOCIATE JUSTICE OF APPEAL**  
First Appellate District  
Division One

34  
**ASSOCIATE JUSTICE OF APPEAL**  
First Appellate District  
Division Two

37  
**ASSESSOR**  
VOTE FOR ONE

38  
**PUBLIC DEFENDER**  
VOTE FOR ONE

39  
**MEMBER OF THE BOARD OF EDUCATION**  
Nominated by Mayor for  
Confirmation by Electors

32-A  
**NO**

33-A  
**YES**

34-A  
**NO**

35-A  
**YES**

36-A  
**NO**

37-A  
**RUSSELL L. Wolden**  
Incumbent

38-A  
**GEORGE M. Del Secco**  
Businessman

39-A  
**WILLIAM C. McDonnell**  
Attorney  
at Law

40-A  
**EDWARD T. Mancuso**  
Incumbent

41-A  
**YES**

42-A  
**NO**

**JOHN G. Levison**

11  
**. Sherk**  
the office for  
scribed by law?

Shall  
**A. F. Bray**  
be elected to the office for  
the term prescribed by law?

Shall  
**Herbert C. Kaufman**  
be elected to the office for  
the term prescribed by law?